

CiA® 402-CANopen Drives and Motion Control Profile for the SilverSterling

Included Files:

CiA 402 Initialization SS 20120604.qcp

Unit 17 - Remote Configure 16.qcp

Overview

CiA® 402 refers to CAN in Automation (CiA) CANopen® Drives and Motion Control Profile 402. The defining documents are available from <http://www.can-cia.org/> (See their respective trademarks.)

Note: The latest specification 302v3 (proposal) contains a significant number of options. The specification (proposal) is also dynamic as additional features are added by various members of the Special Interest Group (SIG).

This Application Note describes QuickSilver Controls implementation of the CiA 402 specification. The 402 operation is implemented by downloading a special initialization and operational code into the SilverSterling unit. The minimum code revision is 11-2x. Many of the objects are directly mapped in the firmware, while other objects are mapped to “user” registers and evaluated by the 402 initialization program.

CANopen® and CiA® are registered community trade marks of CAN in Automation e.V.

Implementation

CiA 402 is implemented in several layers by many different state machines. CiA 402 also depends upon other specifications (i.e. CiA 301 regarding the CANopen communications).

The Network Management NMT, Communications protocols, Communications profile, and Object Dictionary portions are all implemented in hardware/firmware. The Power Drive System (PDS) finite state automation (FSA), which is the state machine governing power sequencing of the driver, is implemented in the special 402 initialization code. The Homing Mode (hm) and Profile Position Mode (pp) options are implemented.

For this implementation, the various user registers should not be accessed directly (Objects 21xxh), (reading is permissible). Normal interaction should be done using the CiA 402 objects.

Factory options

Several factory options have been implemented:

Status Word 6041h bit 14 high indicates homing completed and ready for other motions.

Homing routines have additional hard stop homing modes. See Homing section.

User Options in the code

Main Init and User Customization [0] holds all of the options the user normally should configure.

Line 9: Identity – sets both the Serial Interface ID. This same value is automatically used to set the CAN ID on line 22.

Lines 11,13,15,17: Configures the serial interface
Line 20 sets the CAN baud rate.

Line 25 allows the default TPDOs to be enabled or disabled. A system using SDOs for verified communications would not need (or want) the TPDOs active. A value of 0 leaves them deactivated, a value of 1 is default and activates them.

Line 27 allows the unit to power up automatically to “Operation Enabled” without going through the normal startup sequence. 402 standard operation should have this disabled (0)

Lines 30, 32, 34, 36 configure the brake function. If not brake is present, Brake IO Bit number (line 36) to 0 and the brake function will be disabled; if the brake is to be used, select the IO that will be used (i.e. setting this register to 7 will use IO7). The brake activate time is the delay to allow the brake to go to the locked state before the drive is disabled . The brake release time is the time needed for the brake to allow free rotation after the drive has been enabled and before any motion is allowed. IO direction to release brake: The IO bit selected will be set to the selected state (0 = low, 1=high) to cause the driver to release the brake. If used with a controller with 24v IO, normally a low (0) would be used to energize the brake, releasing clutch and allowing free rotation. If using your own driver from IO1-IO7, a resistor should be used to pull the IO to the brake-locked polarity until the unit has had time to become energized. IO 4, 5, 6, and 7 have only a 200k internal pull-up resistor internally, so a 4.7k resistor to either +5v or 0v (your brake-locked level) should suffice. **NOTE:** as the brake bit is user configurable, it is not reflected in the brake bit of the IO word. The user **must avoid** writing to the IO bit being used for the brake! The IO configuration word may be set to mask this bit so that it can not be overwritten via the IO word. See CANopen manual, object 60Feh.

Lines 39-46 – Do not modify. These disable the motor prior to configuration.

Lines 51 and 53 are normally left AUTO to select the appropriate voltage for the motor when the unit is configured.

Lines 58 and 60 are used to tune the motor controller to the load. The default normally works from open shaft to about a 5:1 inertial mismatch. See tuning application note for details.

Line 63 sets the motor direction corresponding to a positive motion. CW is the default and refers to CW direction with the shaft facing you.

Line 65 and 67 sets the anti-hunt constants to allow the motor not to dither when stopped. They may be set to 0 to disable the anti-hunt. See command reference manual for more details.

Line 69 sets the S-curve factor. This is used only in some of the homing moves, and not for the normal motions. Normally 0.

Lines 72, 74, and 76 configure the negative limit switch, the positive limit switch and the home switch, respectively. The limit switches need to be disabled (as shown) if not present to prevent a Fault upon entering "Operation Enabled" due to the detection of an "outside limits" condition. If disabled, these three switches default to IO1, IO2, and IO3, active high. See CANopen manual object 2004 for configuration to other IO.

Line 78 – leave enabled for standard 402 with these parameters configured via CAN. Disable to allow the various parameters to be configured.

Lines 79-118 configure the various motion parameters and response for faults if line 78 is disabled. See CANopen manual for details.

Line 123 sets the maximum error allowed before indicating motion error.

Line 128 sets the default digital filter for all digital inputs on the IO channels.

Basics

The drive device is controlled primarily by the use of the Control Word and Target Values, with fault and status feedback provided via the Status Word.

The PDS FSA state machine controls the sequencing of power to the drive, and access to drive motion. It also provides the ability to react to faults and to disable the drive if so needed.

The various configuration registers are normally configured using SDO operations. The status and command word operations are often set and read using PDO communications, but can also be managed using SDO operations. PDO operation can "be in the background", but are not confirmed, and can also use up significant amounts of bus time if there are many units all reporting their positions continuously while moving. The SDO method allows control of bus activity as the vast majority of packets are the SDO commands and their responses.

Line 25 (above) should be set to disable the PDO operations if they are not being used, so as to minimize bus traffic. The choice of operation is a system level decision.

Control Word and Status Word – System State Machine

Object 6040h is used to request state transitions while Object 6041h reflects the current state of the State Machine. The boxed names represent States, while the numbered arrows represent Transitions. The numbered states (#) are the internal states used in the implementation. In each case, the state reflected by Object 6041h is updated when the transition has been completed. Fault Reaction Active is the exception in that the fault is immediately reported when the fault is detected, while the fault reaction is still underway; when the reaction is completed, the state then automatically transitions to Fault.

State Machine Transition Diagram

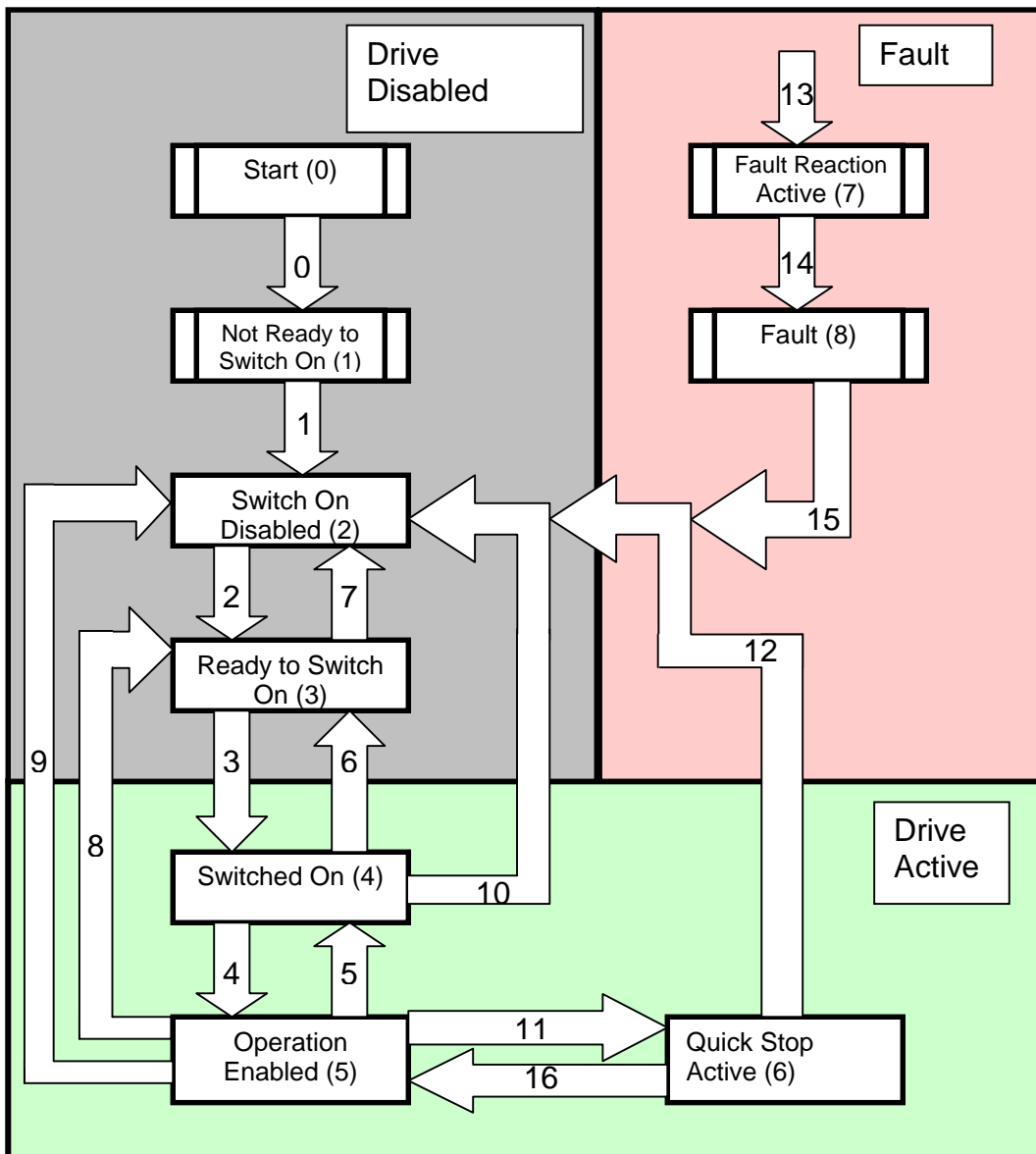

Note (#) are internal states used in QCI implementation

CAN Dictionary Object 6040h writes to the Control Word input (request) to the State Machine, while Object 6041 displays the Status Word (actual State Machine state).

One set of bit fields in the Control Word is used to implement the commands to the PDS FSA state machine, while others are dependent upon the operation mode (selected via Object 6060h Mode of Operation and displayed via 6061h Mode of Operation Display).

The rising edge of Bit 7 is used to reset a fault, while bits 3,2,1,0 of the Control Word are used to request transitions from the current PDS FSA state to a new state. In state Operation Enabled, Bit 8 halts a current motion, while the functions of Bits 9, 6, 5, and 4 are dependent upon the current Mode of Operation. Bit 10 is reserved, while bits 15, 14, 13, 12 are “Manufacturer specific” – not currently used, but provided to allow additional functions may be added to the code to take advantage of these.

Bit Definitions:

- Bits 15..11 = Manufacturer specific (optional – may be implemented in user code)
- Bits 10 = reserved
- Bit 9 = Operation mode specific (vary according to mode selected)
- Bit 8 = Halt
- Bit 7 = Fault Reset
- Bits 6..4 = Operation mode specific (vary according to mode selected)
- Bit 3 = Enable Operation
- Bit 2 = Quick Stop
- Bit 1 = Enable Voltage
- Bit 0 = Switch On

Control Word 6040h: “State Transition Commands” Bits

This table shows the encoding of the various PDS FSA operations. These operations cause the state machine to make the various noted transitions.

	Fault Reset	Enable Oper.	Quick Stop	Enable Volt	Switch On	
OPERATION	Bit 7	Bit 3	Bit 2	Bit 1	Bit 0	Transitions
"Shutdown"	0	X	1	1	0	2,6,8
"Switch On"	0	0	1	1	1	3 (switch on)
"Disable Voltage"	0	X	X	0	X	7,9,10,12 according to state
"Quick Stop"	0	X	0	1	X	7,10,11 according to state
"Disable Operation"	0	0	1	1	1	5
"Enable Operation"	0	1	1	1	1	3&4,4,16
"Fault Reset"	Rising	X	X	X	X	15

Note: “Enable Operation” from state “Ready to Switch on” will perform transitions 3 and 4 in succession.

State Transition Events

Transition 0: Startup => Not Ready to Switch ON

Event: Reset - self-test/initialization – happens before CAN is configured. (This transition automatically occurs in initialization routine.)

Transition 1: Not Ready to Switch ON => Switch On Disabled

Event: Successful initialization - Activate Communication (This transition automatically occurs in initialization routine.)

Transition 2: Switch On Disabled => Ready to Switch On

Event: "Shutdown" command received from host

Transition 3: Ready to Switch On => Switched On

Event: "Switch On" command received from host - switch on power section (if applicable), drive still disabled.

Transition 4: Switched On => Operation Enable

Event: "Enable Operation" command received from host. Enable the drive function.

Transition 5: Operation Enable => Switched On

Event: "Disable Operation" command received from host. Disable drive operation. Affected by Objects 605Ch.

Transition 6: Switched On => Ready to Switch On

Event: "Shutdown" command received from host. Switch off power section (if applicable).

Transition 7: Ready to Switch On => Switch On Disabled

Event: "Quick Stop" or "Disable Voltage" command received from host. Transition states

Transition 8: Operation Enable => Ready to Switch On

Event: "Shutdown" command received from host. Switch off power section, motor free to rotate. Affected by Objects 605Bh.

Transition 9: Operation Enable => Switch On Disabled

Event: "Disable Voltage" command received from host. Switch off power section, motor free to rotate.

Transition 10: Switched On => Switch On Disabled

Event: "Disable Voltage" and "Quick Stop" command received from host. Switch off power section, motor free to rotate.

Transition 11: Operation Enable => Quick Stop Active

Event: "Quick Stop" command received from host - execute Quick Stop function. This operation is affected by Object 605Ah.

Transition 12: Quick Stop Active => Switch On Disabled

Event: "Quick Stop" or "Disable Voltage" command received from host, turn off power section. Disable the Drive and Drive Voltage (if applicable).

Transition 13: Any State => Fault Reaction Active

Event: A fault has been detected in the drive - react to the fault according to Objects 605Eh

Transition 14: Fault Reaction Active => Fault

Event: fault recovery completed - disable the drive, power may be switched off. Affected by Objects 605Eh

Transition 15: Fault => Switch On Disabled

Event: "Fault Reset" command received from host - reset fault detect (if fault has cleared), bit "Fault Reset" must be cleared by host

Transition 16: Quick Stop Active => Operation Enable

Event: "Enable Operation" command received from host (if quick-stop-option-code – Object 605Ah is 5,6,7 or 8 - enable the drive

NOTE: If a command is received which causes a change of state, this command must be processed completely and the new state attained before the next command can be processed.

NOTE: "Drive function disabled" means no energy can be supplied to the motor, reference values (torque, velocity, position) may be processed, but no signal to the motor results. If the Brake options has been configured, the brake is turned on, the brake enable delay elapses, then the drive is disabled; the reverse process happens when the drive function is enabled: the drive is first enabled, the brake is disabled, the brake disable delay is allowed to elapse, and then motion is allowed.

Status Word 6041h

The PDS FSA State is reflected in Status Word (6041h):

- Bit 15 = Manufacturer specific (opt)
- Bit 14 = Manufacturer Specific (1=Home has completed, ok to use pp mode)
- Bits 12..13 = Operation mode specific (opt)
- Bits 11 = Internal limit active (position range exceeded, velocity limit, etc.)
- Bit 10 = Target Reached (1=Axis motion done; the axis is stopped but not necessarily at target if Halt active)
- Bit 9 = Remote (1=listening to 6040h, 0 = operating as local master - will not respond to a command written to 6040h)
- Bit 8 = manufacturer specific (opt)
- Bit 7 = Warning (opt)
- Bit 6 = Switch On Disabled
- Bit 5 = Quick Stop (0 = Drive is reacting to a Quick Stop request)
- Bit 4 = Voltage Enabled (1 = enabled)
- Bit 3 = Fault (1 = Fault)
- Bit 2 = Operation Enabled (1=Enabled)
- Bit 1 = Switched On (1=Switched On)
- Bit 0 = Ready to Switch On (1=Ready to Switch on)

Again, bits in the Status Word may be grouped to aid understanding. Current State is reflected in bits {6, 5, 3, 2, 1, 0}, with various combinations given names corresponding to the earlier state diagram:

Bits						State
6	5	3	2	1	0	
0	x	0	0	0	0	(1) Not Ready to Switch On
1	x	0	0	0	0	(2) Switch on Disabled
0	1	0	0	0	1	(3) Ready to Switch On
0	1	0	0	1	1	(4) Switched On
0	1	0	1	1	1	(5) Operation enabled
0	0	0	1	1	1	(6) Quick Stop Active
0	x	1	1	1	1	(7) Fault Reactive
0	x	1	0	0	0	(8) Fault

Description of States

Not Ready to Switch ON:

Driver “HV” Power Disabled - if there is a provision to switch drive power. Processor power on, drive initialization in progress, BRAKE on in this state, if present

Switch On Disabled:

Driver “HV” Power Disabled - if there is a provision to switch drive power. Processor power on, Initialization complete, drive parameters set up, drive disabled

Ready to Switch On

Ready to have High Voltage power applied.

Switched On

High Voltage enabled to driver, power amp ready, drive function disabled

Operation Enabled

Power enabled to driver, no faults have been detected, drive function is enabled and there is power to motor. The servo is active.

Quick Stop Active

Power enabled to driver, Quick stop function is being executed, drive function is enabled, and power is applied to motor.

Note: If quick stop option codes 0x605A value is set to 5 through 8, the drive will remain active and may be switched quickly to Operation Enabled; other options will cause the drive to be switched off and the state to transition to Switch On Disabled.

Fault Reaction Active

A fault has occurred in drive, quick stop being executed. Drive enabled and power are applied to drive while reacting.

Fault

A fault has occurred, high voltage MAY be switched off, and drive function is disabled.

Power up Sequencing

Note: an example of the power up sequencing is provided in “Unit 17 - Remote Configure 16.qcp – also see **CiA 402 Initialization** section below for flow diagrams.

- 1) At power up/reset the state machine first reports a Transitions to “Switch on Disabled” once the CANopen communications are operating. This state is only entered from a power up / hard reset and indicates the drive needs to be configured.
- 2) The Master configures/reconfigures PDO configuration objects if the default configuration is not as needed.
- 3) The Master configures the various reaction options, default velocities, etc.
- 4) The master sets the slave NMT state to operational. (This is needed before going into PDS FSA state “Operation Enabled” to avoid a communications fault.)
- 5) The Master sends operation “Shutdown” to exit state “Switch on Disabled”. This acknowledges that the master has completed any configuration needed following a power up / reset of the drive.
- 6) The drive transitions to state “Ready to Switch On”
- 7) The Master sends operation “Switch On” (optionally the master may send operation “Enable operation”, which will perform both Switch On and “Enable operation functions”).
- 8) The drive will transition to state “Switched On”
- 9) The master sends operation “Enable operation” (if it did not already send it in step 7)
- 10) The drive will verify drive enable and power are present and enable the drive. If this is the first enabling since power up, the drive will perform a commutation alignment “start-up wiggle”. Servo operation is enabled. Operational fault detection is enabled to verify that heartbeat is active and NMT state is “operational”. The drive will monitor object 6060h Mode of Operation to determine what motions are asked of the drive.
- 11) The master must home the drive before performing any motions. Homing is needed to set any motion limits as well as to determine the reference position for motion.
 - a. Master configures homing speeds and accelerations and offset, as well as maximum velocities and accelerations / decelerations (if not previously set) – See Objects Implemented for Details.
 - b. Master selects homing method via object 6098h (if not previously set)
 - c. Master selects mode hm (6 = homing mode) via object 6060h
 - d. Slave responds with mode hm (6) via object 6061h. Status Word bits 12 (Home Found and 13 (Homing error) are cleared.
 - e. Master activated homing mode by setting Control Word bit 4 (Start Homing).
Note: Control Word Bit 8 (Halt) must be low. A high will cause the homing to stop; bringing it low again will cause the homing to restart.
 - f. When the homing starts, the drive clears Status Word bit 10 (Target reached) to indicate motion is active.
 - g. If the zero point is located in the homing motion, the drive sets Status Word bit 12 (Home found), followed by Status Word bit 10 (Target Reached) when the motion completes. If an error is encountered, then the drive sets Status Word bit 13 (Homing Error), followed by Status Word bit 10 (Target Reached) when the motion stops. Manufacturer specific Status Word bit 14 (Homing Completed) is also set, indicating the drive is ready to accept other motion commands. The end

- of travel switches as well as the soft position limits are engaged when Status Word bit 14 is set.
- h. The Master may clear Control Word bit 4 (Start) once the homing has started. If it has not done so, it should clear the bit now.
- 12) The Master changes to Profile Position Mode of operation
- a. The master selects mode pp (1=profile position) via object 6060h Mode of Operation.
 - b. The drive responds by setting object 6061h Mode of Operation Display to pp (1). Status word bit 12 (Set Point Acknowledge) is cleared.
- 13) The Master selects Next position for motion
- a. The master sets object 607Ah New Target Position to the next desired target position. Absolute or relative positioning is determined by Control Word bit 6 (Absolute = 0, Relative=1). Control Word bit 8 (Halt) should be low to enable the next motion. Control Word bit 5 (Change Set Point Now) and bit 9 (Change on Set Point) should be set according to need (both low if doing point-to-point).
 - b. The lower motion limit object 607DH sub 1 and upper motion limit object 607DH sub 2 should be set if soft motion limits are desired. The upper motion limit must be larger than the lower motion limit in order for them to be active.
 - c. Profile Velocity 6083H and Max Profile Velocity 607FH should be configured for the move. Profile Acceleration 6083H, Profile Deceleration 6084H, Quick stop deceleration 6085H, Max Acceleration 60C5H, and Max Deceleration 60C6H should also be configured for the move if not previously configured.
 - d. Quickstop option 605AH selects the style of quick stop, if used.
 - e. Halt options 605DH should also be selected
 - 0 (Reserved - use slow ramp)
 - 1 use slow ramp
 - 2 use quick stop ramp
 - 3 slow down on current limit
 - 4 slow down on voltage limit
 - any other = use quick stop ramp
 - f. Control word (6040H) signals used within PP mode:

New Setpoint (Bit 4)	=> 0->1 latches new set point
Change Setpoint Immediately (Bit 5)	=> 1 = next set point immediately (override active motion)
Relative/Absolute (Bit 6)	=> 0 target is absolute position, 1=position is relative to current trajectory generator value
Halt (Bit 8)	=> 1=axis shall be stopped according to 605Dh , 0=position / continue positioning
Change on Setpoint (Bit 9)	=> 1 = keep axis in motion and change to new setpoint as it passes the old setpoint (without stopping if in same direction)
 - g. (Control Word Bit 4 is already low) If not already set, the master sets/clears Control Word (6040H) bits 5,6,8,9 to their desired state so as to determine the type and effect of the next setpoint.
- 14) The master sets Control Word bit 4 (New Set Point). This causes the new set point and style of setpoint to be latched and the motion started.
- 15) The drive responds by setting Status Word bit 12 (Set Point Acknowledge).

Status word 6041H optional and mode dependent bit definition in PP mode:

Target Reached (Bit 10)	=> 1=target reached (trajectory done, and if not halted, actual position is within 20 counts of target position (error limit is hard wired in logic in PP move setpoint process line 162)
Set point Ack (Bit 12)	=> Rising edge indicates set point information has been latched, falling edge indicates ready for next set point
Following Error (Bit13)	=> 1 = excessive following error
Manufacturer (Bit 15)	=> 1= we have completed a home, enable position limits, etc.

- 16) If multiple set points are being used, the set point logic implements a 1 deep FIFO allowing the next move or segment of move to be latched. If the FIFO is full, the Set point Acknowledge will remain high until the next set point has been consumed, it will then go low to indicate that the state machine will accept another set point.
- 17) The Master configures the next position for motion
- The master may now clear Control Word bit 4 (New Set Point) and change the Target Position and other target related inputs including various accelerations and velocities for the next motion (the prior values are latched internally).
 - The drive responds by clearing Status Word bit 10 (Set Point Acknowledge) when drive is ready to accept another set point into storage. Note that the drive will always accept a new set point if Control Word bit 5 (Change Set Point Now) is set.
- 18) The Master may now continue setting set points, choosing to allow completion before continuing, overriding, or change on set point (update the acceleration and velocities without stopping when the first set point is reached). The change on set point assumes the new set point is in the same direction of travel; if a reversal in direction is needed, the motion is stopped at the first set point, and then the new motion to the following set point is initiated. See CiA 402v3 for more details.
- 19) Once the set points commanded motions have completed (that is the requested trajectory has completed) and the absolute value of the error is less than 20 counts, Status 6041H Target Reached (Bit 10) will be asserted. If moved beyond 20 counts bit 10 will be cleared until the error is again less than 20 counts. This means that a actuator which is jammed will cause a delay in the Target Reached, which should cause timeout logic in the master to determine the cause. Observing the Target position at the desired target location and not moving indicates the commanded motion is completed, and observing the error value excessively large will indicate the motor is jammed. If the error is decreasing, the axis is exceeding its capability and is catching up.
- 20) Additional PP move operations are initiated by the actions at step 13 (above). Other modes of action may be initiated by changing the mode via Register 6060H.

Background fault detection:

If a command error is detected, such as a move that would exceed physical speed limits, any motion currently in process is ramped to a halt, brake, if any is set, and the motor driver is disabled. The background thread (Thread 2) is checked to make sure it is still operating. If Thread 2 has faulted, the program is restarted, which will bring the machine back to the power up state. If thread 2 is still operating, a CAN error 2002.2 H will have bit 10 set and

the internal fault response routine will react according to the selected error behavior as selected via object 1029.2H

CANopen NMT state is checked and, if CAN has switched to either restarted or preoperational, then the Comm Fault Reaction routine is started to shutdown the motions as the communications have been lost.

The driver enable status is checked as well as the power supply voltage to determine if machine is already active and a fault is present. A fault will force a Fault Reactive action.

Position limits, both hard (switches) and soft limits are not active until the unit has been homed, to avoid interfering with the homing operations. Soft position limits are only active if they have been configured (upper limit > lower limit).

Internal limits, including position limits and velocity limits, are checked in the background with bit 11 of Status word 6041h set high to reflect limits active and cleared when no longer active.

Control Word (6040h): Mode Specific Bits

Control Word (6040h) Bits are also Mode Specific in their meaning:

Mode Specific Command Bit Functions

Bit	Profile Position (pp)	Profile Velocity (pv)	Profile Torque (tq)	Homing Mode (home)	Interpolate Position (ip)	Encoder Follow (ef)
4	New Set Point	reserved	reserved	Start Homing	Enable ip	New Mode
5	change set now	reserved	reserved	reserved	reserved	Follow
6	abs/relative	reserved	reserved	reserved	reserved	Stop Hard
8	Halt	Halt	Halt	Halt	Halt	Halt
9	Change on Set Point	reserved	reserved	reserved	reserved	

Note: only Profile Position and Homing Mode are currently Implemented.

Mode Specific Bit Functions – Descriptions

Mode	Bit	Function	0	1
pp	4	New Set Point	Ignore input target position	Use new target position
home	4	Start/finish		Start homing
ip	4	Enable ip	No interpolation	Start interpolation mode
ef	4	Change mode		Rising edge
pp	5	Change Set	Finish current move, then start next	Override current motion
ef	5	Follow Mode	Follow Encoder	Stop following encoder
pp	6	abs/rel	Absolute Positioning	Relative Positioning
ef	6	Stop Hard	Use same accel ramp to stop	Stop hard
All	8	Halt	Position mode	Halt
pp	9	Change on S.P.	Reach set point stopped before changing	Change on Set point

402 Mode Dependent Status Bits

Status Word (6041h) Bits {12, 13} are Mode specific in their meaning. The Mode of Operation is selected via object 6060h with the current mode displayed via 6061h:

Mode Specific Status Bits

Mode	Bit 12	Bit 13
pp	1 = Set Point Ack	1 = Following Error
pv	1=Speed Ack	1=Max Slip Error
tq	Reserved	Reserved
home	1=Homing completed	1=Homing Error
ip	1=ip mode active	Reserved
ef	1 =Set point ack	Reserved

Objects implemented

For more details, see SilverLode CANopen Manual. Note: All position units are encoder counts. All Velocity units are SilverLode Native units ($2^{31}-1$ represents 4000 RPM). Acceleration and Deceleration are in SilverLode Native Units (Change in Velocity units per 120 us).

- 1000h Device Type
- 1001h Error Register
- 1002h Manufacturer Status Word
- 1003h – Predefined Error Field
- 1005h COB-ID SYNC
- 1006h Communication Cycle (SYNC) Period
- 1007 h Synchronous Window Length
- 100Ch Guard Time (Guarding not supported – use heartbeat)
- 100Dh Life Guarding (Guarding not supported – use heartbeat)
- 1012h TIME STAMP COB-ID
- 1013h High Resolution Time Stamp
- 1014h COB-ID EMCY
- 1015h EMCY Inhibit Time
- 1016h Consumer Heartbeat Time => Need to configure for Heartbeat monitoring
- 1017h Heartbeat Producer Time => Need to configure for Heartbeat generation
- 1018h Identity Object
- 1019h Synchronous Counter
- 1029h Error Behavior Object => Need to configure to determine NMT action for Serious Error
- 1200h SDO Server 1 Parameters (default)
- 1201h SDO SERVER 2 Parameters => configure if a second SDO Server is desired
- 1280h SDO CLIENT 1 Parameters (default)
- 1281h SDO Client 2 Parameters => configure if a second SDO Server is desired
- 1400h 1st Receive PDO Communications Record => Preconfigured – Change if desired
Update immediately
- 1401h 2nd Receive PDO Communications Record => Preconfigured – Change if desired
Update immediately
- 1402h 3rd Receive PDO Communications Record => configure if desired
- 1403h 4th Receive PDO Communications Record => Preconfigured – Change if desired
Update immediately
- 1600h First Receive PDO Mapping => Preconfigured – Change if desired
6040h (Command – 16 bits)
- 1601h Second Receive PDO Mapping => Preconfigured – Change if desired
6040h (Command – 16 bits), 607Ah (New Target Position – 32 bits)
- 1602h Third Receive PDO Mapping => configure if desired
- 1603h Fourth Receive PDO Mapping => Preconfigured – Change if desired
6040h (Command – 16 bits), 6098h (Homing method – 8 bits),
6060h (Mode of operation – 8 bits)
- 1800h First Transmit PDO Communications Parameters => Preconfigured – Change if desired
Trigger on change, No Inhibit time, No Timer
- 1801h 2nd Transmit PDO Communications Parameters => Preconfigured – Change if desired
Trigger on change, inhibit time = 20ms, Timer = 100ms (slowed due to almost constant

change of target value)

1802h Third Transmit PDO Communications Parameters => configure if desired

1803h Fourth Transmit PDO Communications Parameters => configure if desired

1A00h First Transmit PDO Mapping => Preconfigured – Change if desired

6041h (Status – 16 bits)

1A01h Second Transmit PDO Mapping => Preconfigured – Change if desired

6041h (Status – 16 bits), 6064h (Actual Position – 32 bits),

6061h (Mode of Operation Display – 8 bits)

1A02h Third Transmit PDO Mapping => configure if desired

1A03h Fourth Transmit PDO Mapping => configure if desired

2000h Critical Error Mask => Select sources to set CAN error bit => Preconfigured
Heartbeat Error (NMT state is checked in code according to PDS FSA state of driver)

2001 EMCY Report Mask => Select sources to set as reported errors => configure errors
to be reported

2002 CAN Errors Reported Register

2003h Trigger Event Driven PDO

2004h Limit Switch and Home Switch Mapping => Preconfigured – change if desired

IO1=Lower Limit Switch, IO2 = Upper Limit Switch, IO3=Home Switch, all active high.

Change this object to select other switches or to change active state.

2005h Heartbeat Monitoring Status/State

2006h Read/Clear CAN Hardware Error Status Bits

2007h Current CAN ERRORS Register

2008h Remote Input Register Map (not used in 402 implementation)

2009h SSI Data Port

200Ah CAN Switch Data

2100h to 21FCh User Register Mapping to CAN Data Dictionary: DO NOT ACCESS in
CiA 402 mode (OK to read)

Special Factory Mode of Encoder Follow (ef) also uses - ok to access these registers for that mode:

218C.1h Register 140 = Acceleration factory (see EGM) => Not Implemented this Revision

218D.1h Register 141 = Scale Factor * 10,000,000 (see EGM) => Not Implemented this
Revision

6007h Abort Connection Option Code => Not Implemented this Revision

603Fh – Most Recent Error Code

6040h Control Word => used to send commands to drive

6041h Status Word => used to monitor status

605Ah Quick Stop Options => defaults to 0 needs to be configured

605Bh Shutdown Option => defaults to 0 needs to be configured

605Ch Disable Option => defaults to 0 needs to be configured

605Dh Halt Option => defaults to 0 needs to be configured

605Eh Fault Reaction Option => defaults to 0 needs to be configured
6060h Modes of Operation => used to select mode
6061h Modes of Operation Display => used to display mode
6062h Position Demand Value (Current trajectory value)
6063h Position Actual Value (Current position measured by encoder)
6064h Position Actual Value (Current position measured by encoder)
607Ah New Target Position =>Set the next Set Point in Profile Position (pp) mode
607Ch Home Offset => defaults to 0 – configure for as needed for application
607Dh Position Limits Array => defaults to 0 (disabled) – configure if needed
607Fh Maximum Profile Velocity => defaults to 0 needs to be configured
6081h Profile Velocity => defaults to 0 needs to be configured
6083h Profile Acceleration => defaults to 0 needs to be configured
6084h Profile Deceleration => defaults to 0 needs to be configured
6085h Quick Stop Deceleration => defaults to 0 needs to be configured
6098h Homing Method => use to select homing method
6099h Homing Speeds Array => defaults to 0 needs to be configured
609Ah Homing Acceleration => defaults to 0 needs to be configured
60C5h Maximum Acceleration => defaults to 0 needs to be configured
60C6h Maximum Deceleration => defaults to 0 needs to be configured
60F2h Position Demand Value
60F4h Following Error Actual Value
60FCh Position Demand Value
60FDh Digital Inputs => use to read digital IO
60FEh Digital Outputs =>used to configure extended IO as well as to read and write to it
6502h Supported Drive Modes (pp and hm modes allowed)
67FFh Single Device Type

Needs to be configured

Optional to configure

Used to handshake/interface with the system

Informational

Homing Methods

Homing Method (6098h) selects what homing method will be used. Methods 1 through 35 are defined in 402v3.0 while methods -1 through -128 are reserved for custom homing methods. Currently Special Methods -4 through -1 have been implemented.

The default limit switches are Negative Limit Switch = IO1, Positive Limit Switch = IO2, Home Switch = IO3. These may be reconfigured via Object 2004h.

Methods -1 and -2: Hard Stop

Method -1: Home on Negative Hard Stop

The torque is set to 50% of normal (value configured when home was initiated). Initial movement is negative. Motion continues until a Moving Error is Detected. The motion is stopped, the error is cleared, and torque is returned to normal. The home position is the hard stop position.

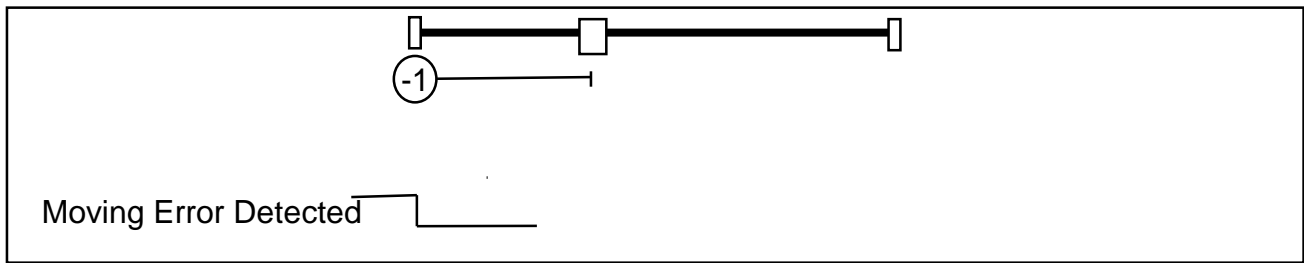

Method -2: Home on Positive Hard Stop

The torque is set to 50% of normal. Initial movement is positive. Motion continues until a Moving Error is Detected. The motion is stopped, the error is cleared, and torque is returned to normal. The home position is the hard stop position.

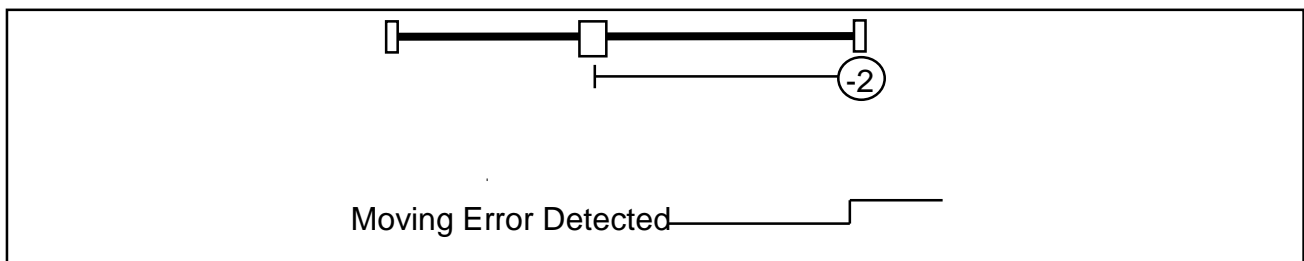

Methods -3 and -4: Hard Stop plus Index

Method -3: Home on Negative Hard Stop and Index Pulse

The torque is set to 50% of normal. Initial movement is negative. Motion continues until a Moving Error is Detected. The motion is stopped, the error is cleared, and torque is returned to normal. Motion is started in the positive direction. The home position is the first index pulse in the positive direction from the hard stop.

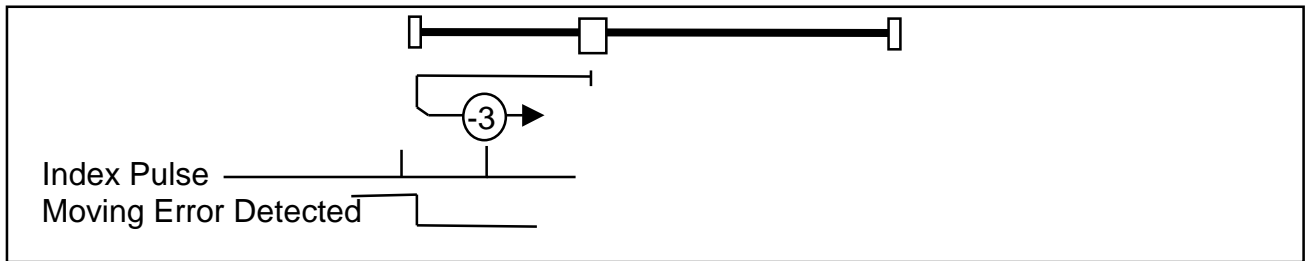

Method -4: Home on Positive Hard Stop and Index Pulse

The torque is set to 50% of normal. Initial movement is Positive. Motion continues until a Moving Error is Detected. The motion is stopped, the error is cleared, and torque is returned to normal. Motion is started in the negative direction. The home position is the first index pulse in the negative direction from the hard stop.

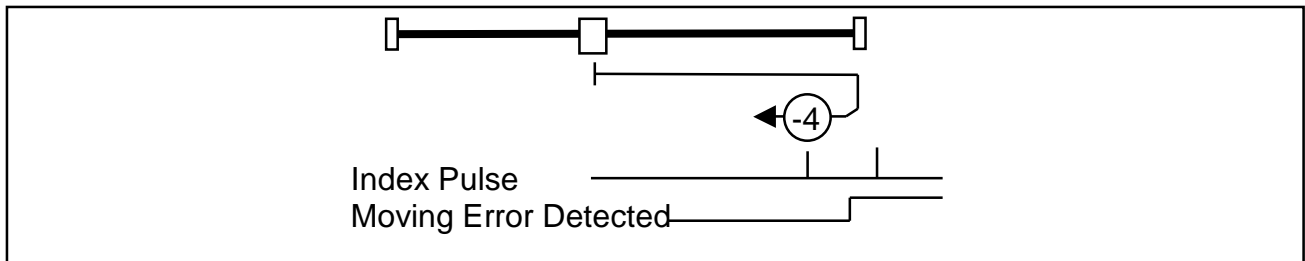

Methods 1 and 2: Limit Switch plus Index

Method 1: Home on Negative Limit Switch and Index Pulse

Initial movement is negative if the negative limit switch is inactive. The home position is the first index pulse in the positive direction from the position where the negative limit switch becomes inactive.

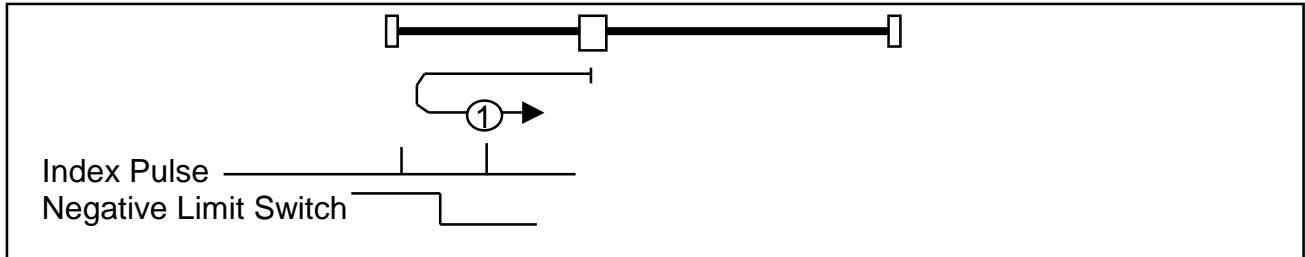

Method 2: Home on Positive Limit Switch and Index Pulse

Initial movement is positive if the positive limit switch is inactive. The home position is the first index pulse in the negative direction from the position where the positive limit switch becomes inactive.

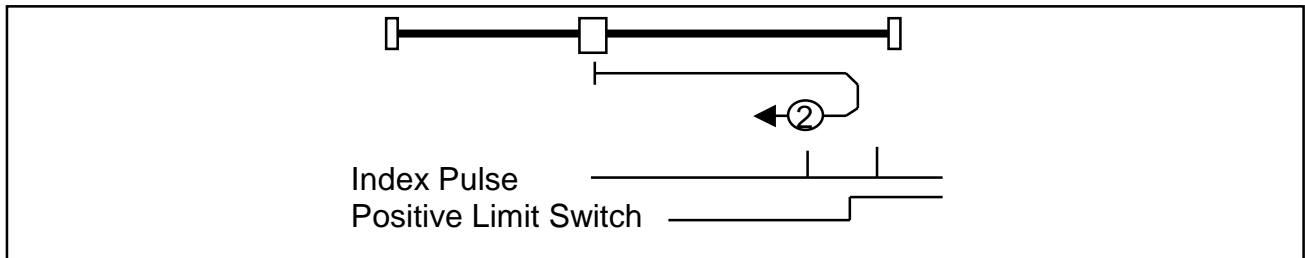

Methods 3 through 6: Single Transition Home Switch plus Index

Method 3: Homing on the Positive Home switch and Index Pulse

This method requires a home switch that goes active with movement in the positive direction. Seeks the Home Switch transition, then finds the first index pulse in the negative direction.

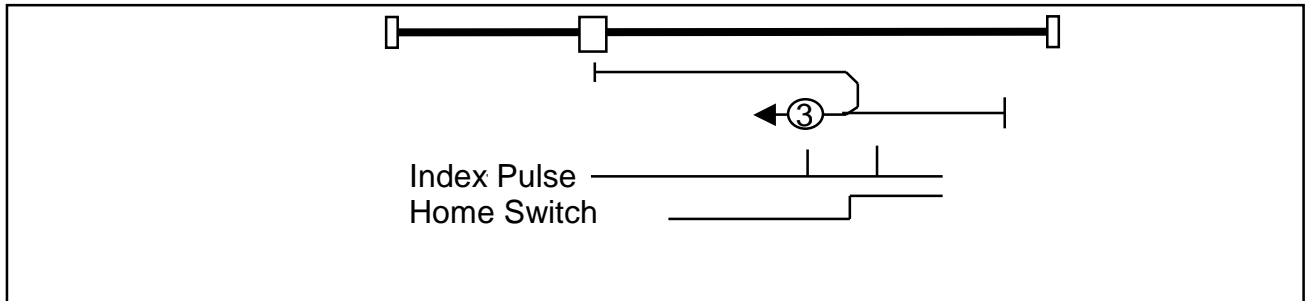

Method 4: Homing on the Positive Home switch and Index Pulse

This method requires a home switch that goes active with movement in the positive direction. Seeks the Home Switch transition, then finds the first index pulse in the positive direction.

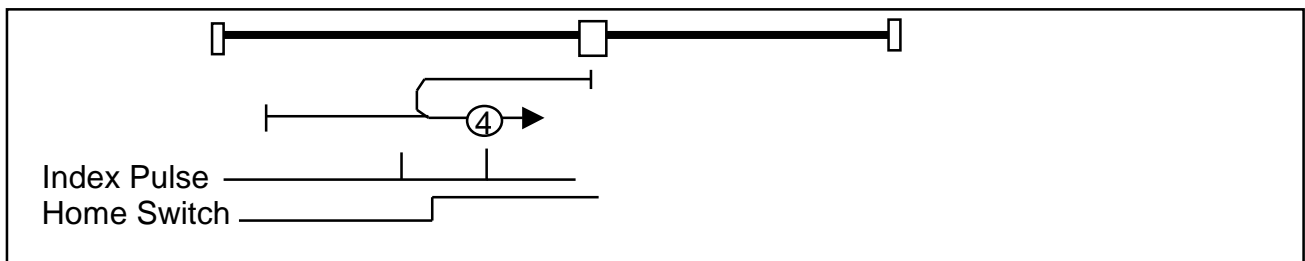

Method 5: Homing on the Positive Home switch and Index Pulse

This method requires a home switch that goes inactive with movement in the positive direction. Seeks the Home Switch transition, then finds the first index pulse in the positive direction.

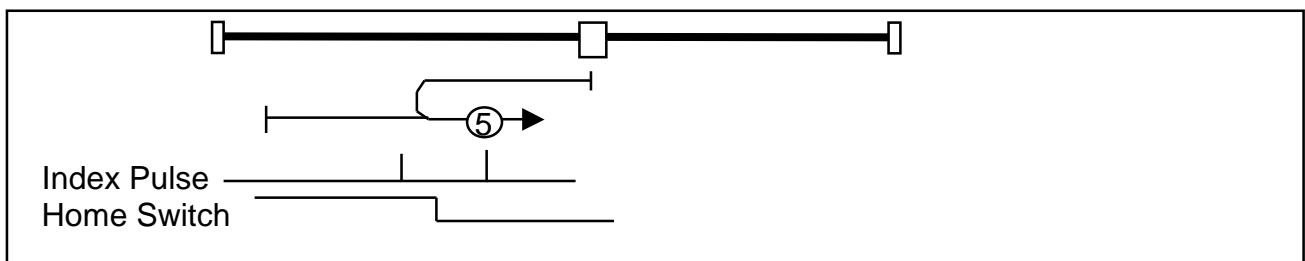

Method 6: Homing on the Positive Home switch and Index Pulse

This method requires a home switch that goes inactive with movement in the positive direction. Seeks the Home Switch transition, then finds the first index pulse in the negative direction.

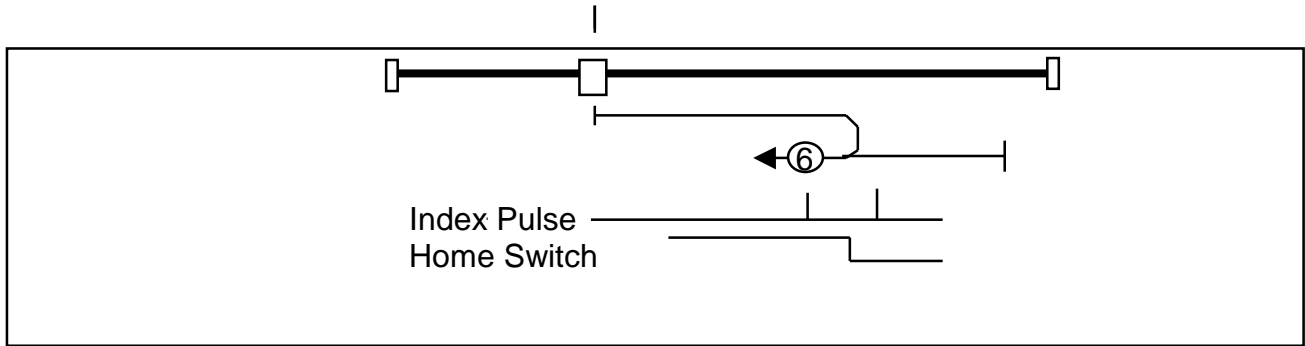

Methods 7 to 14 Limited Range Home Switch, Limit Switched and Index

Used with a home switch that is active over only a portion of the travel. Assumes motion from negative to positive produces inactive – active – inactive states on the home switch. The motion will be made until the desired edge of the home sensor is found, then until the desired index is found.

Method 7: Home Switch and Index: Negative Home Edge, Negative Index

Assumes starting position is in the negative inactive or the active regions of the home switch. If actually in the positive inactive region, the positive limit switch will activate, causing the motion to reverse until the wanted edge has been found.

Seeks the lower home switch edge, and then finds the first index in the negative direction.

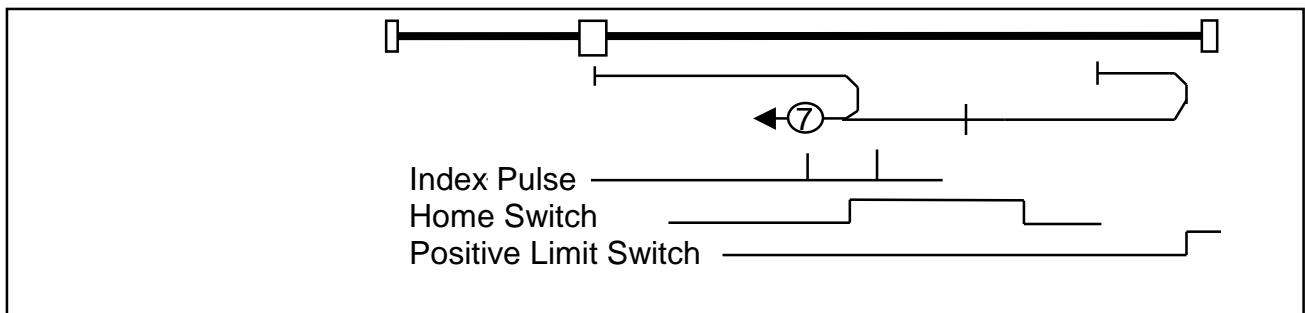

Method 8: Home Switch and Index: Negative Home Edge, Positive Index

Assumes starting position is in the negative inactive or the active regions of the home switch. If actually in the positive inactive region, the positive limit switch will activate, causing the motion to reverse until the wanted edge has been found.

Seeks the lower home switch edge, and then finds the first index in the positive direction.

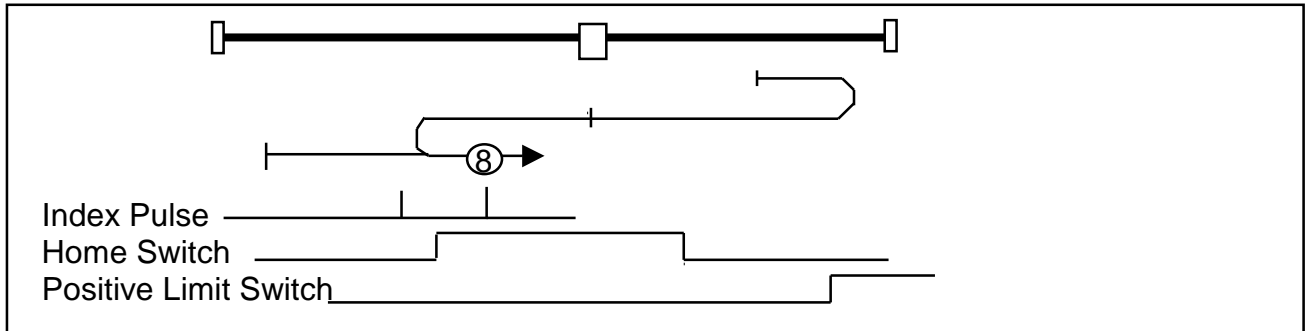

Method 9: Home Switch and Index: Positive Home Edge, Negative Index

Assumes starting position is in the negative inactive or the active regions of the home switch. If actually in the positive inactive region, the positive limit switch will activate, causing the motion to reverse until the wanted edge has been found.

Seeks the upper home switch edge, and then finds the first index in the negative direction.

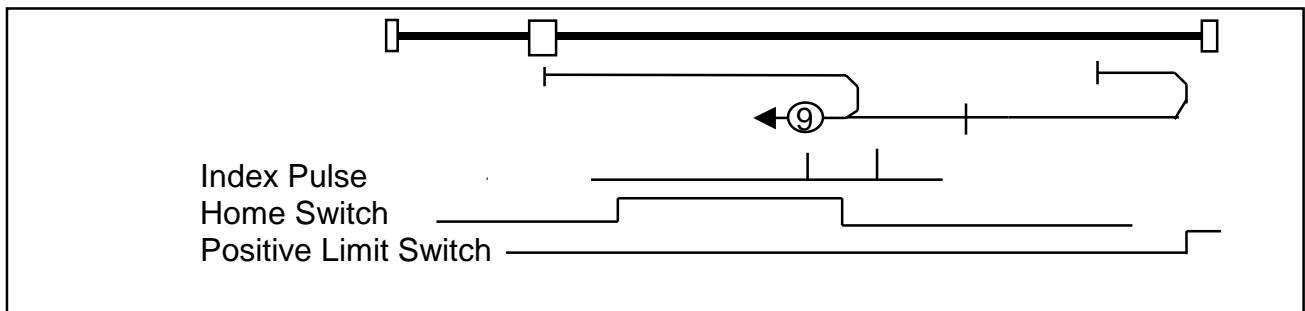

Method 10: Home Switch and Index: Positive Home Edge, Positive Index

Assumes starting position is in the negative inactive or the active regions of the home switch. If actually in the positive inactive region, the positive limit switch will activate, causing the motion to reverse until the wanted edge has been found.

Seeks the upper home switch edge, and then finds the first index in the positive direction.

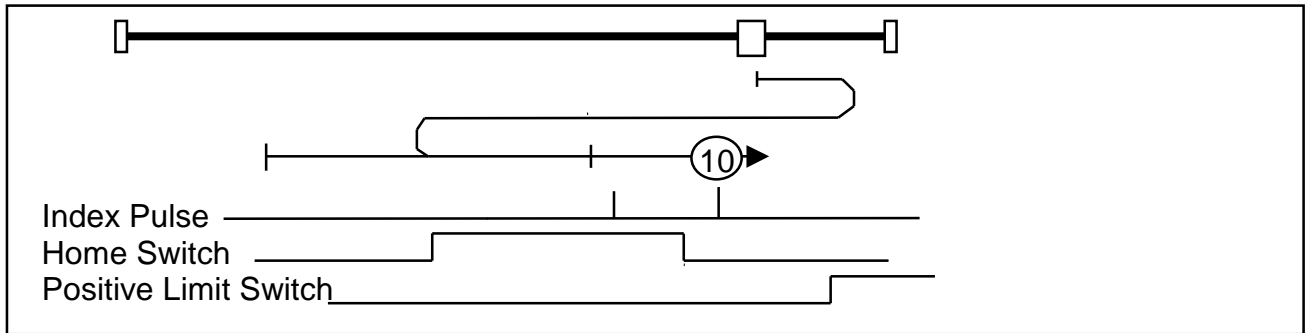

Method 11: Home Switch and Index: Positive Home Edge, Negative Index

Assumes starting position is in the positive inactive or the active regions of the home switch. If actually in the negative inactive region, the negative limit switch will activate, causing the motion to reverse until the wanted edge has been found.

Seeks the upper home switch edge, and then finds the first index in the negative direction.

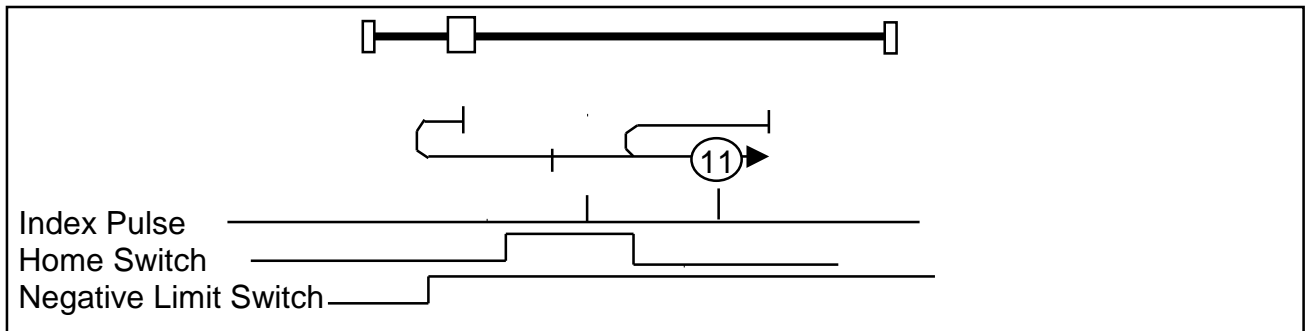

Method 12: Home Switch and Index: Positive Home Edge, Positive Index

Assumes starting position is in the positive inactive or the active regions of the home switch. If actually in the negative inactive region, the negative limit switch will activate, causing the motion to reverse until the wanted edge has been found.

Seeks the upper home switch edge, and then finds the first index in the positive direction.

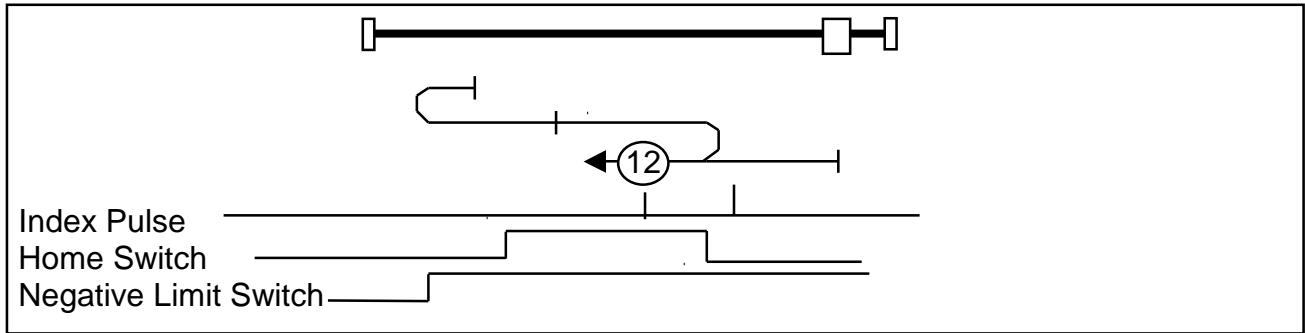

Method 13: Home Switch and Index: Negative Home Edge, Negative Index

Assumes starting position is in the positive inactive or the active regions of the home switch. If actually in the negative inactive region, the negative limit switch will activate, causing the motion to reverse until the wanted edge has been found.

Seeks the lower home switch edge, and then finds the first index in the negative direction.

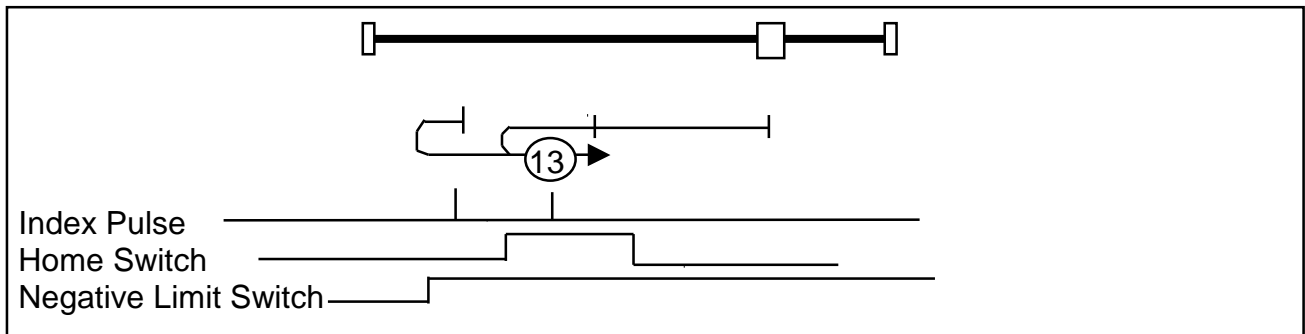

Method 14: Home Switch and Index: Negative Home Edge, Positive Index

Assumes starting position is in the positive inactive or the active regions of the home switch. If actually in the negative inactive region, the negative limit switch will activate, causing the motion to reverse until the wanted edge has been found.

Seeks the lower home switch edge, and then finds the first index in the positive direction.

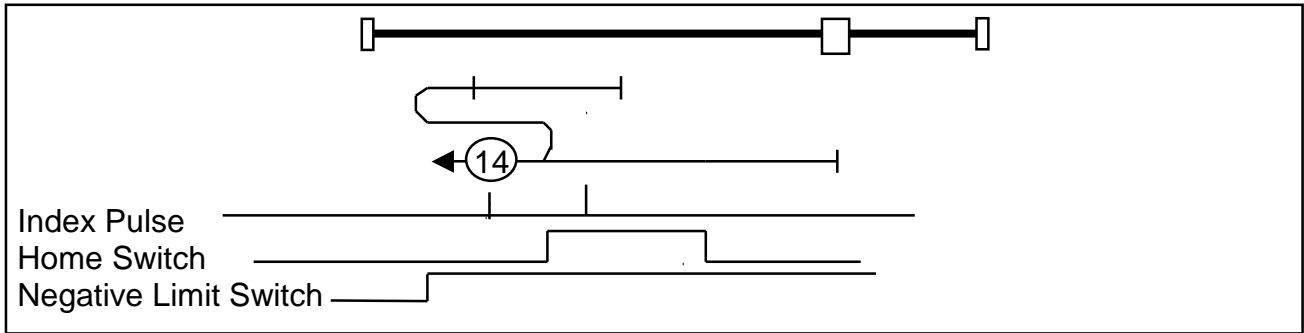

Note: A slight modification from CiA 402 for starting inside Home Switch Active to allow seeking Zero at Zero Speed rather than Switch Speed.

Methods 15, 16: Reserved

These methods reserved for future expansion.

Methods 17 and 18 – Home on Limit Switch

Method 17: Home on Negative Limit Switch

Initial movement is negative if the negative limit switch is inactive. The movement is positive until the negative limit switch becomes inactive. The transition point to inactive defines the home position.

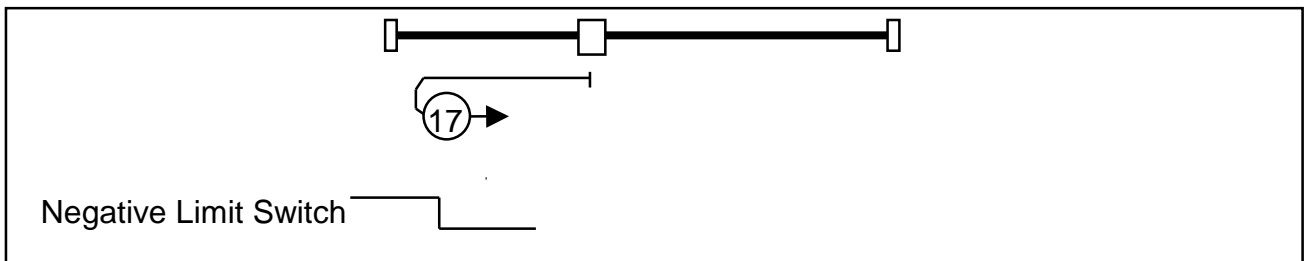

Method 18: Home on Positive Limit Switch

Initial movement is positive if the positive limit switch is inactive. The movement is negative until the positive limit switch becomes inactive. The transition point to inactive defines the home position.

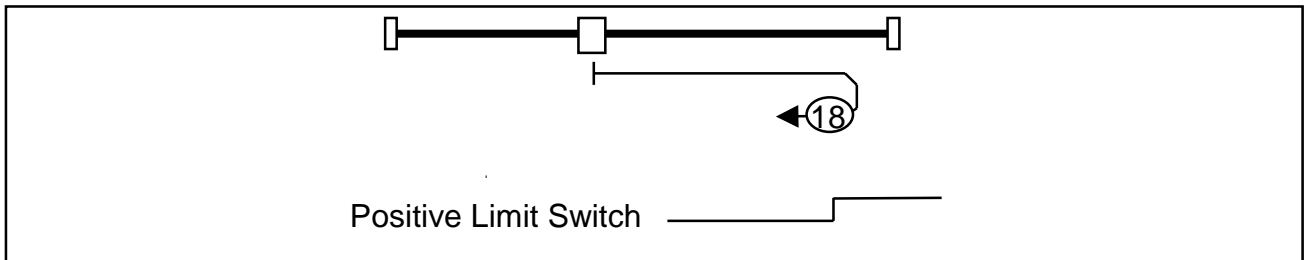

Methods 19 and 22: Single Transition Home Switch

Method 19: Homing on the Positive Home switch, Negative edge

This method requires a home switch that goes active with movement in the positive direction. Moves positive if the home switch is inactive, until it becomes active. Moves in the negative direction until the home switch becomes inactive. Transition point is home.

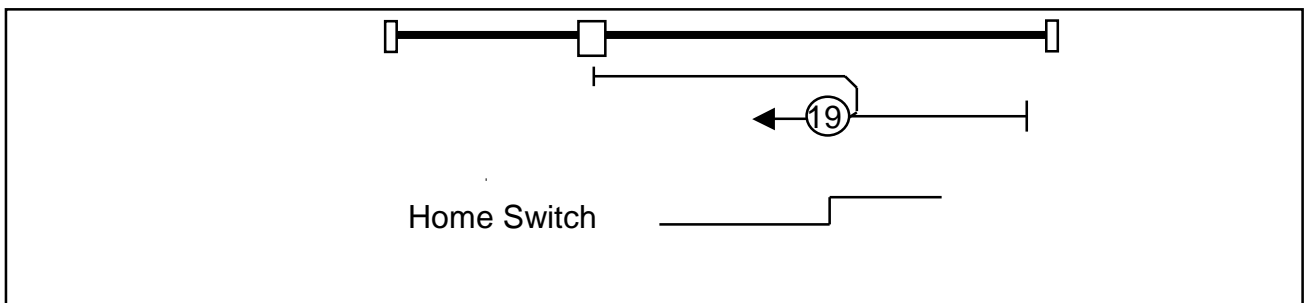

Method 20: Homing on the Positive Home switch, Positive edge

This method requires a home switch that goes active with movement in the positive direction. Moves negative if the home switch is active, until it is inactive. Moves in the positive direction until the home switch is active. Transition point is home.

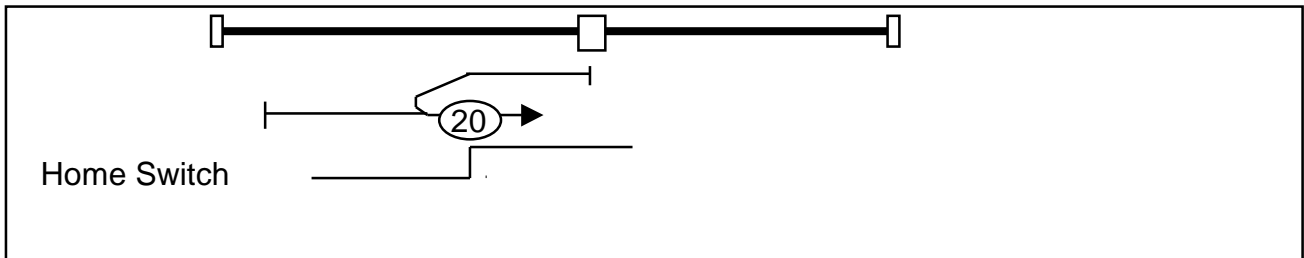

Method 21: Homing on the Negative Home switch, Positive edge

This method requires a home switch that goes inactive with movement in the positive direction. Moves negative if the home switch is inactive, until it is active. Moves in the positive direction until the home switch is inactive. Transition point is home.

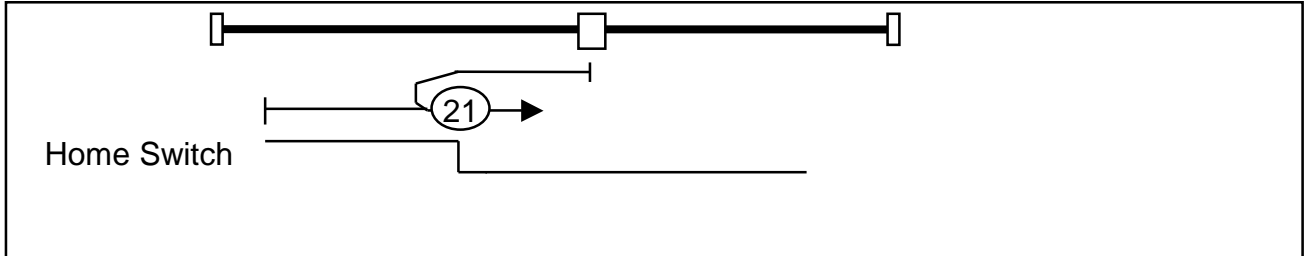

Method 22: Homing on the Negative Home switch, Negative edge

This method requires a home switch that goes inactive with movement in the positive direction. Moves positive if the home switch is active, until it is inactive. Moves in the negative direction until the home switch is active. Transition point is home.

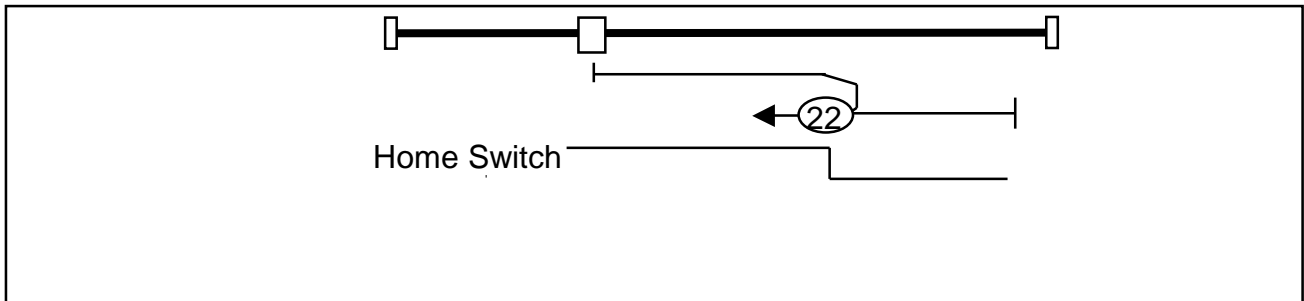

Methods 23 through 25: Two Transition Home Switch and Limit Switches

Used with a home switch that is active over only a portion of the travel. Assumes motion from negative to positive produces inactive – active – inactive states on the home switch. The motion will be made until the desired edge of the home sensor is found, then until the desired index is found.

Method 23: Home Switch and Index: Negative Home Edge, Negative Direction

Assumes starting position is in the negative inactive or the active regions of the home switch. If actually in the positive inactive region, the positive limit switch will activate, causing the motion to reverse until the wanted edge has been found.

Seeks the lower home switch edge, and then finds the transition in negative direction.

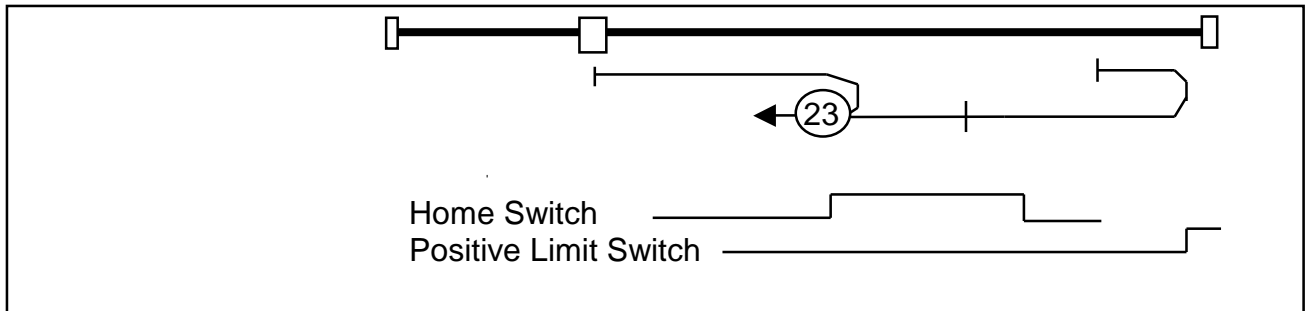

Method 24: Home Switch and Index: Negative Home Edge, Positive Direction

Assumes starting position is in the negative inactive or the active regions of the home switch. If actually in the positive inactive region, the positive limit switch will activate, causing the motion to reverse until the wanted edge has been found.

Seeks the lower home switch edge, and then finds the transition in the positive direction.

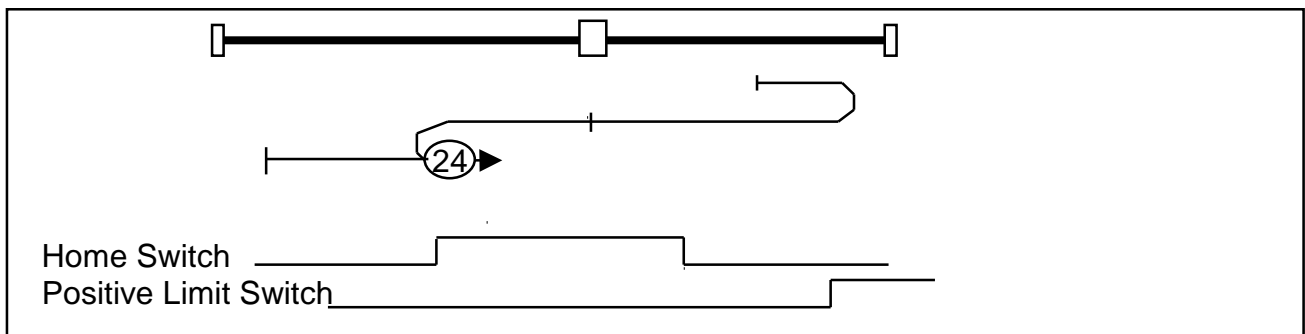

Methods 25 and 30: Two Transition Home Switch, Limit Switches and Index

Method 25: Home Switch and Index: Positive Home Edge, Negative Direction

Assumes starting position is in the negative inactive or the active regions of the home switch. If actually in the positive inactive region, the positive limit switch will activate, causing the motion to reverse until the wanted edge has been found.

Seeks the upper home switch edge, and then finds the transition in the negative direction.

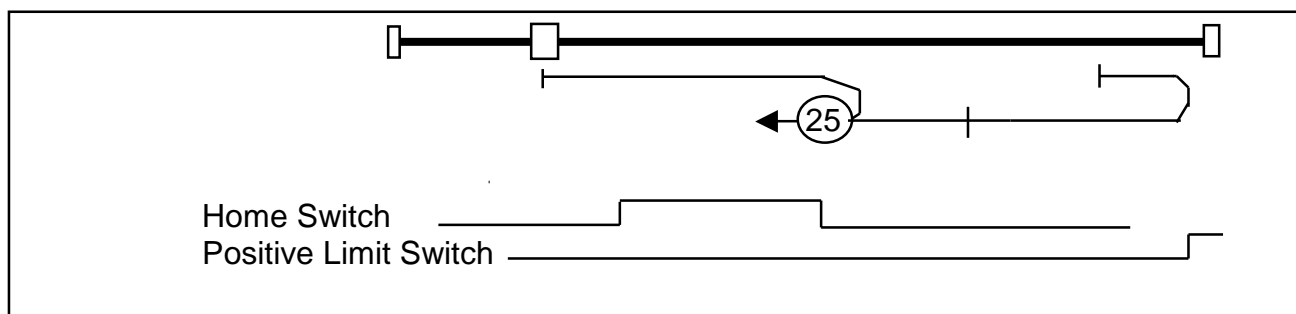

Method 26: Home Switch and Index: Positive Home Edge, Positive Direction

Assumes starting position is in the negative inactive or the active regions of the home switch. If actually in the positive inactive region, the positive limit switch will activate, causing the motion to reverse until the wanted edge has been found.

Seeks the upper home switch edge, and then finds the transition in the positive direction.

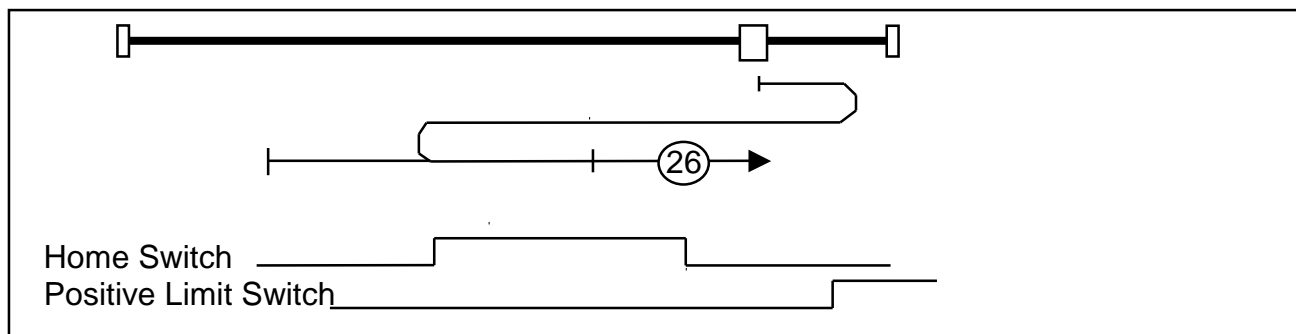

Method 27: Home Switch and Index: Positive Home Edge, Negative Direction

Assumes starting position is in the positive inactive or the active regions of the home switch. If actually in the negative inactive region, the negative limit switch will activate, causing the motion to reverse until the wanted edge has been found.

Seeks the upper home switch edge, and then finds the transition in the negative direction.

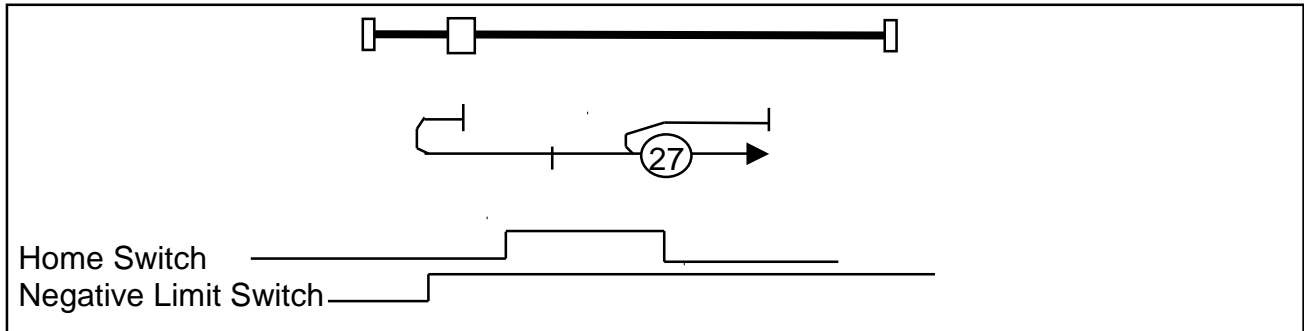

Method 28: Home Switch and Index: Positive Home Edge, Positive Direction

Assumes starting position is in the positive inactive or the active regions of the home switch. If actually in the negative inactive region, the negative limit switch will activate, causing the motion to reverse until the wanted edge has been found.

Seeks the upper home switch edge, and then finds the transition in the positive direction.

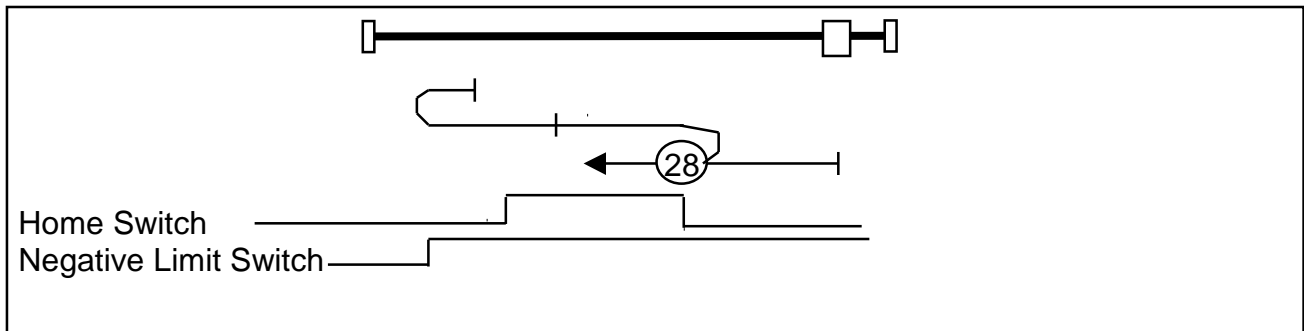

Method 29: Home Switch and Index: Negative Home Edge, Negative Direction

Assumes starting position is in the positive inactive or the active regions of the home switch. If actually in the negative inactive region, the negative limit switch will activate, causing the motion to reverse until the wanted edge has been found.

Seeks the lower home switch edge, and then finds the transition in the negative direction.

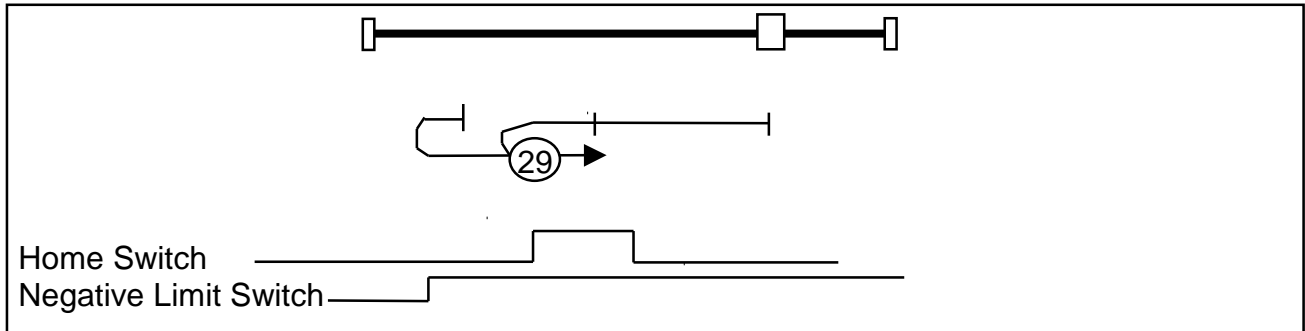

Method 30: Home Switch and Index: Negative Home Edge, Positive Direction

Assumes starting position is in the positive inactive or the active regions of the home switch. If actually in the negative inactive region, the negative limit switch will activate, causing the motion to reverse until the wanted edge has been found.

Seeks the lower home switch edge, and then finds the transition in the positive direction.

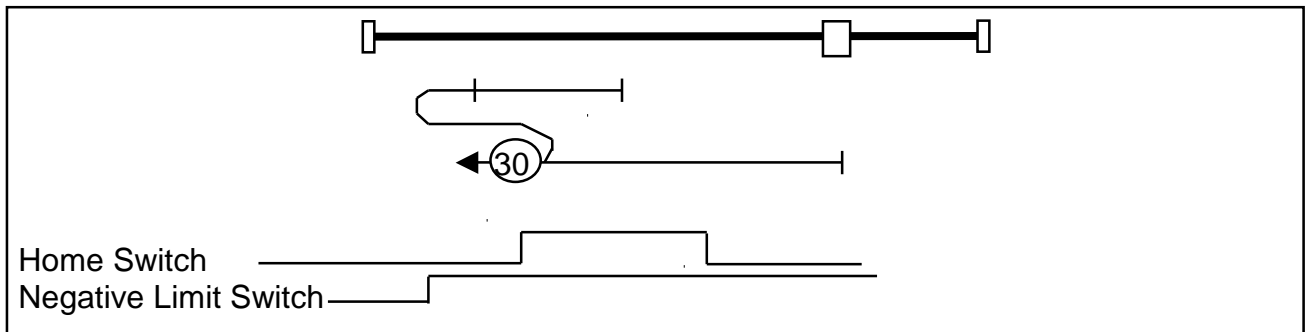

Method 31 and 32: Reserved

These methods reserved for future expansion

Methods 33 and 34: Index

Method 33: Home Negative Index

Moves in the negative direction until next index is located.

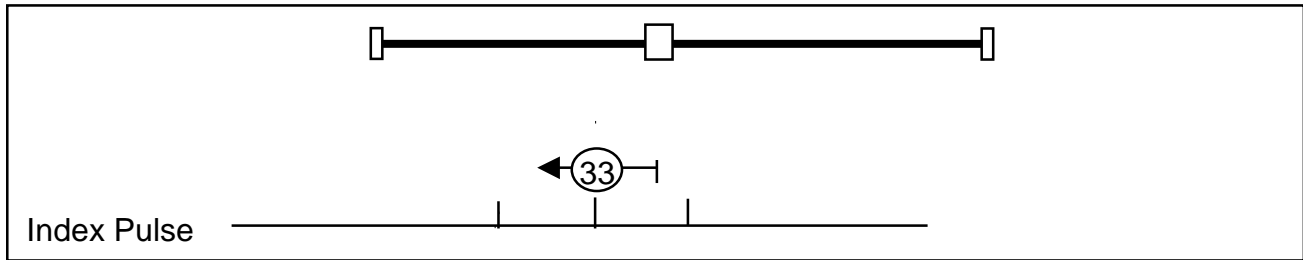

Method 34: Home Positive Index

Moves in the positive direction until next index is located.

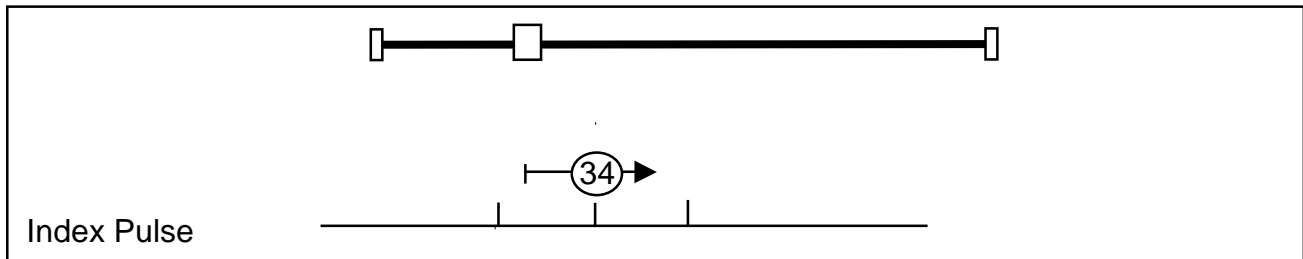

Method 35: Set to current position

Method 35: Home on Current Position

Current position is selected as the new home “zero” position.

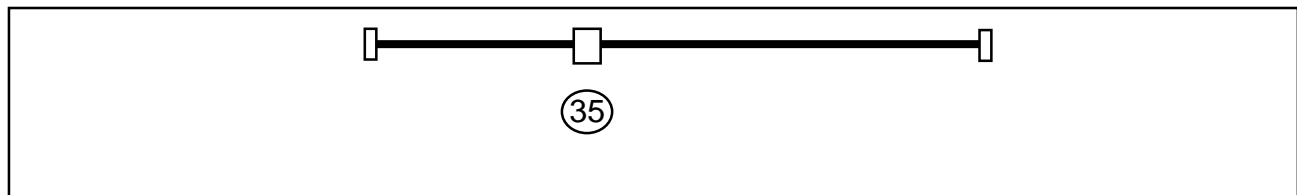

Additional Homing Methods

Additional custom homing methods may be requested by contacting QuickSilver Controls, or by editing the 402 Initialization file. Examples would include home against a hard stop in combination with a sensor or index pulse, etc., to eliminate limit switches in applications in which the hardware is sufficiently robust to support a slow “crash” into a hard stop. Any additional homing methods may be defined to use methods –1 to –128. None of these custom homing routines are currently implemented.

CiA 402 Initialization

A demonstration configuration program is also provided (“Unit 17 - Remote Configure 16.qcp”) to test the 402 implementation.

To use this program file, the 402 drive must be initialized to Unit 16 (by use of the switches if present or by changing the Comm ID for units without CAN ID and CAN Baud switches).

A second drive must be initialized as ID 17 using “Factory Default Initialization - CAN.qcp” Next, “Unit 17 - Remote Configure 16.qcp” must be downloaded.

The program first configures its own local PDOs and then switches itself to NMT operational. Next, it configures the 402 drive acceleration and options to allow operation. Next the 402 drive is switched to NMT operational.

The program then steps through the power machine states from Switch On Disabled to Ready to Switch on, Switched On, Operation Enabled. (Note: no error checking is done in this demo program).

Next, homing mode is selected, using a simple home (home to index - others may be easily selected). Upon completion, the drive then performs two point to point moves, pausing in-between.

Initialization Section

The following code excerpt from “Unit 17 - Remote Configure 16.qcp” shows the start of the initialization of the various configuration objects on the 402 Drive unit.

Note: “CiA 402 Initialization.qcp” has an optional initialization section in Program 2: User CAN register Initialization. To enable local initialization, disable line 2 in this program, and update the various modes, accelerations, decelerations, velocities, and limits as desired. This will reduce the startup overhead if desired.

Initialization code excerpt from “Unit 17 - Remote Configure 16.qcp”.

Line# Oper	Label	Command
5:REM		===== Configure Drive Parameters (Remote unit) =====
6:REM		Set our own state to operational
7:CNL		CAN NMT State = Operational
8:REM		Connect to unit 16 so we can configure it. - use the default SDO link
9:CCTR		CAN Connect to Unit 16
14:REM		Configure Home offset - 0 counts from zero switch location to target zero
15:CDR		CAN Dictionary Access, Remote 0x607C.0 = 0
16:REM		Configure Homing Method - positive to next index
17:CDR		CAN Dictionary Access, Remote 0x6098.0 = 34
18:REM		Homing speed switch - 200 RPM
19:CDR		CAN Dictionary Access, Remote 0x6099.1 = 3.33 Rps
20:REM		Homing speed zero - 30 RPM
21:CDR		CAN Dictionary Access, Remote 0x6099.2 = 0.5 Rps
22:REM		Configure Homing Acceleration - 200 RPM in 20 ms
23:CDR		CAN Dictionary Access, Remote 0x609A.0 = 167.34 Rps/s
24:REM		Max acceleration - 1000 RPM per 40 ms
25:CDR		CAN Dictionary Access, Remote 0x60C5.0 = 417.08 Rps/s
26:REM		Max deceleration - 1000 RPM per 40 ms
27:CDR		CAN Dictionary Access, Remote 0x60C6.0 = 417.08 Rps/s
28:REM		Maximum Profile Velocity = 1000 RPM
29:CDR		CAN Dictionary Access, Remote 0x607F.0 = 16.67 Rps
30:REM		Configure QuickStop Option = 6 = stop on quick stop ramp, leave enabled
31:CDR		CAN Dictionary Access, Remote 0x605A.0 = 6
32:REM		Configure Shutdown Option - 0 (immediatly disable drive)
33:CDR		CAN Dictionary Access, Remote 0x605B.0 = 0
34:REM		Disable Operation Option =1 (slow ramp, then disable driver)
35:CDR		CAN Dictionary Access, Remote 0x605C.0 = 1
36:REM		Configure Halt Option = 2 (Slow down on quick stop ramp)
37:CDR		CAN Dictionary Access, Remote 0x605D.0 = 2
38:REM		Fault Reactive Action = 0 (Disable Drive)
39:CDR		CAN Dictionary Access, Remote 0x605E.0 = 2
40:REM		Set QuickStop Deceleration - 1000 RPM in 100ms
41:CDR		CAN Dictionary Access, Remote 0x6085.0 = 166
42:REM		Set Negative Limit (note - editing shows it as -1000000r)
43:CDR		CAN Dictionary Access, Remote 0x607D.1 = 4284967296
44:REM		Set Positive Limit
45:CDR		CAN Dictionary Access, Remote 0x607D.2 = 10000000
46:REM		Set profile Velocity = 400 RPM

Startup Example:

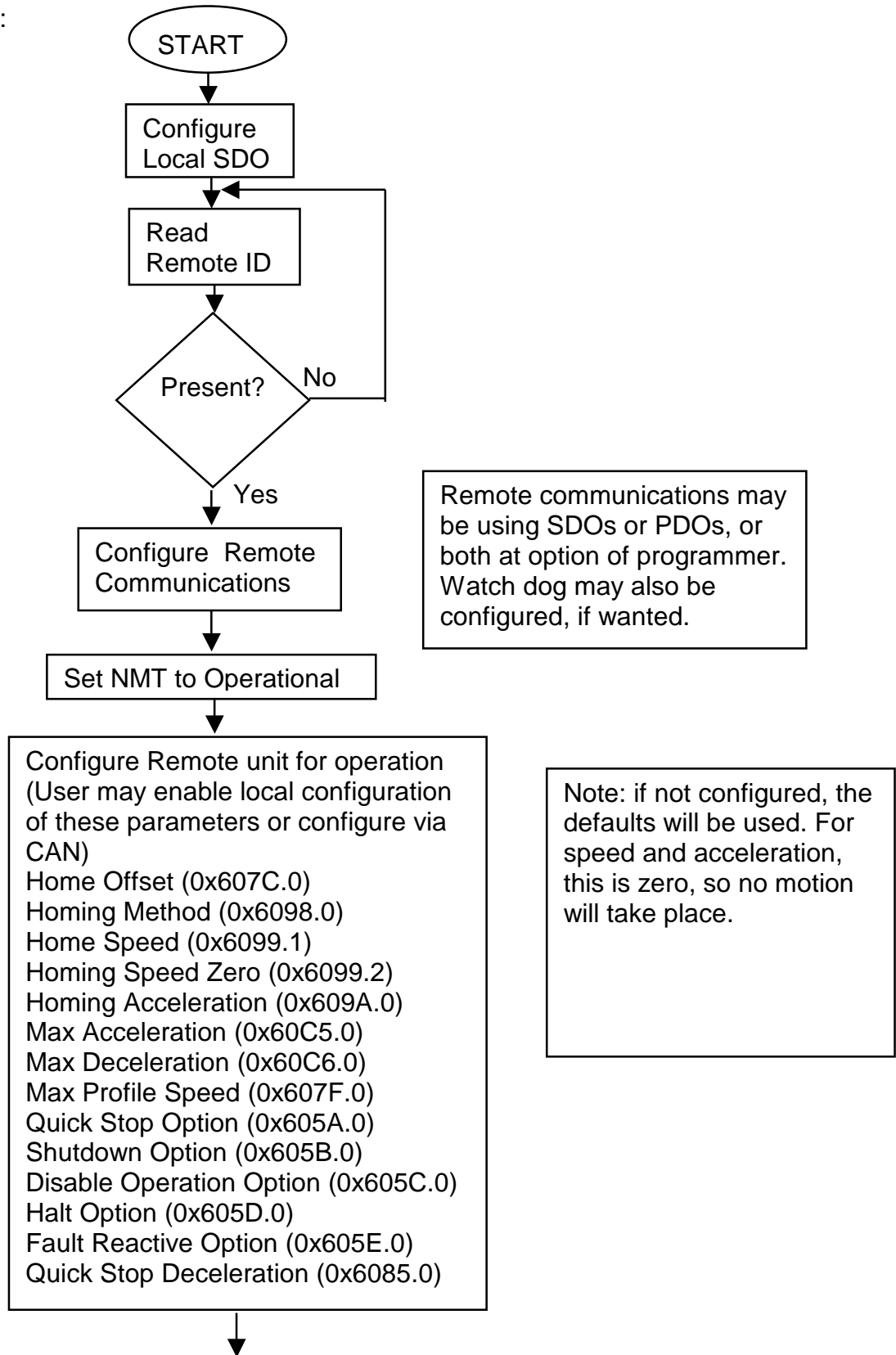

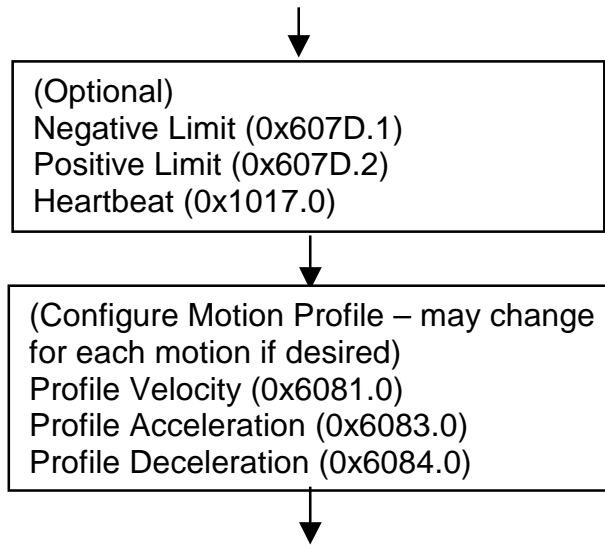

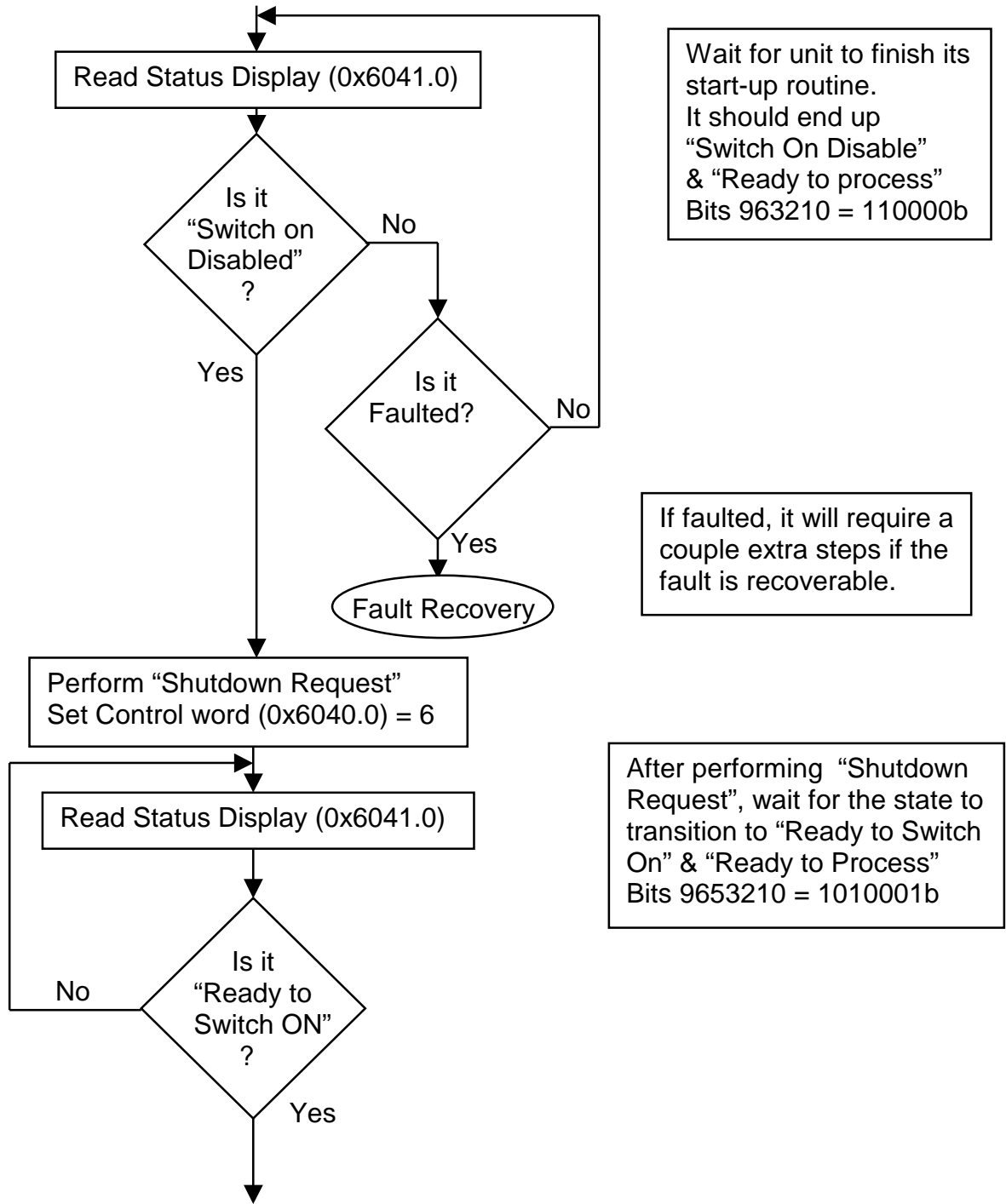

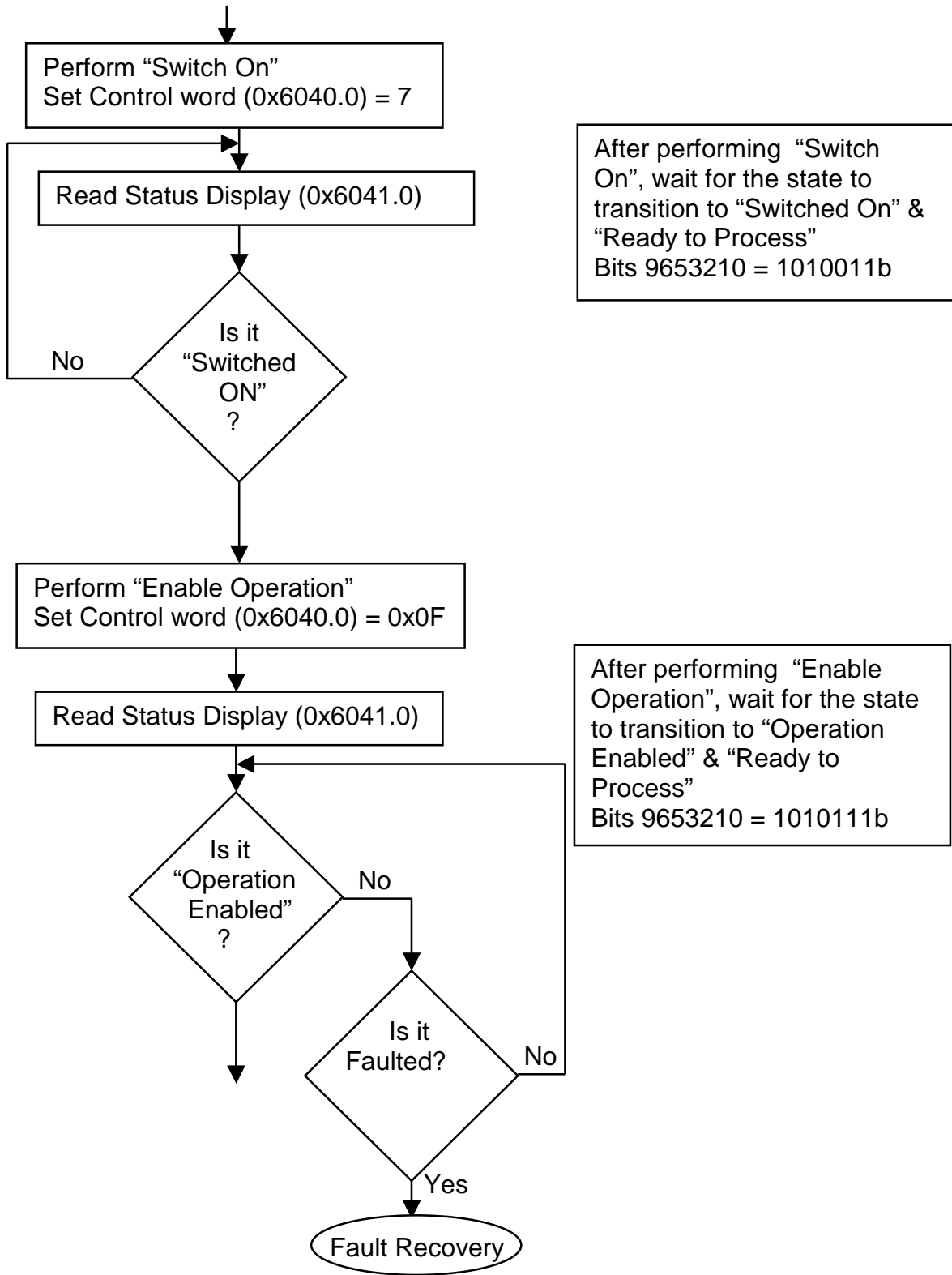

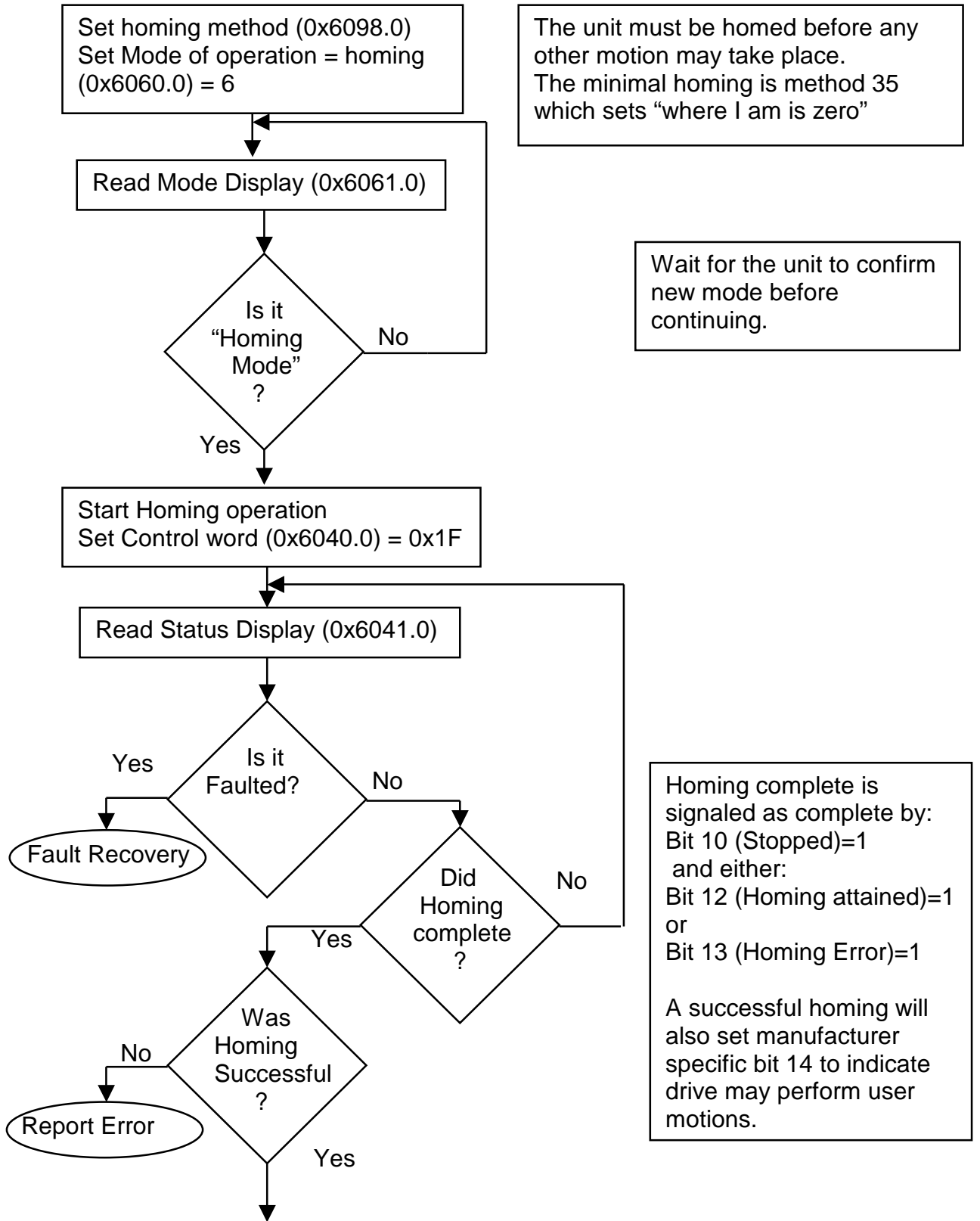

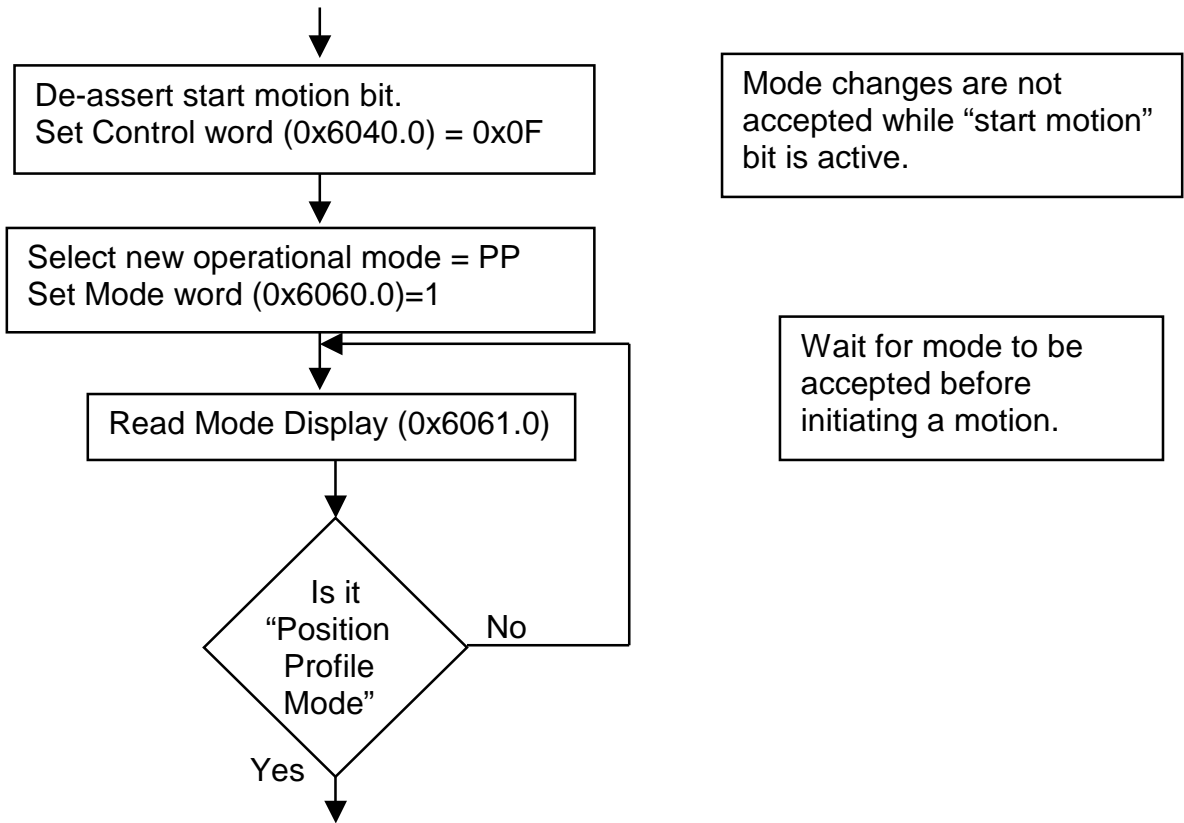

The unit is ready for motion. Motions may be activated one at a time, they may be queued (one started and another waiting), they may be overwritten mid motion, they may be paused (Halted). One motion may be started with the second point of the motion queued such that the first motion does not come to a stop (if the second point is in the same direction of motion), transitioning to the new point, velocity, and acceleration. The hand shaking for these vary, as shown.

All of the following motions assume the unit has been initialized, homed, and set to PP mode.

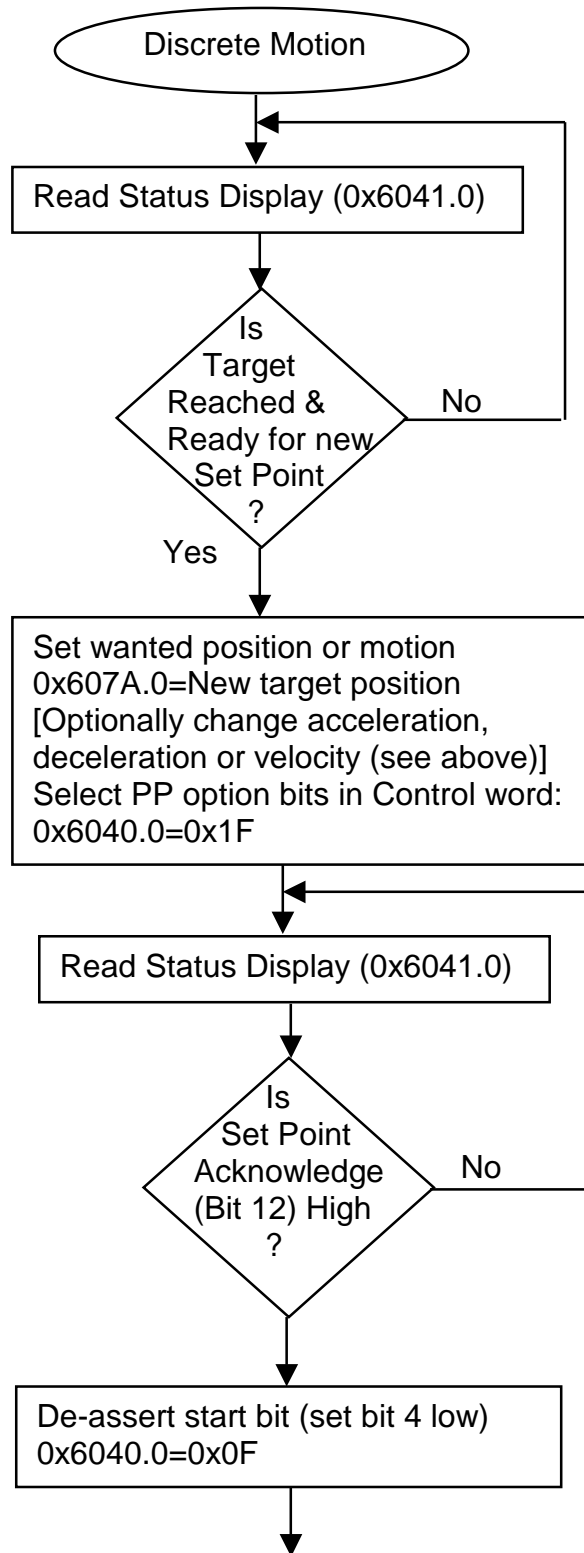

Perform a discrete motion and wait for it to complete

In PP mode,
Bit 12 = Set point Acknowledge (0 if waiting for a new setpoint)
Bit 10 = Target Reached (Stopped)

In example, Target is absolute, complete prior setpoint. No change immediate, no halt., start motion.
Code is 0x1F

PP specific bits in Control Word (0x6040.0)
Bit 4 = New Set point
Bit 5 = Change Set point immediately
Bit 6 = absolute (0) / relative (1)
Bit 8 = Halt current motion (1)
Bit 9 = (0) Complete current set point before evaluating next (come to stop), (1) go to current set point at velocity, then transition to new accel/velocity to reach next setpoint.

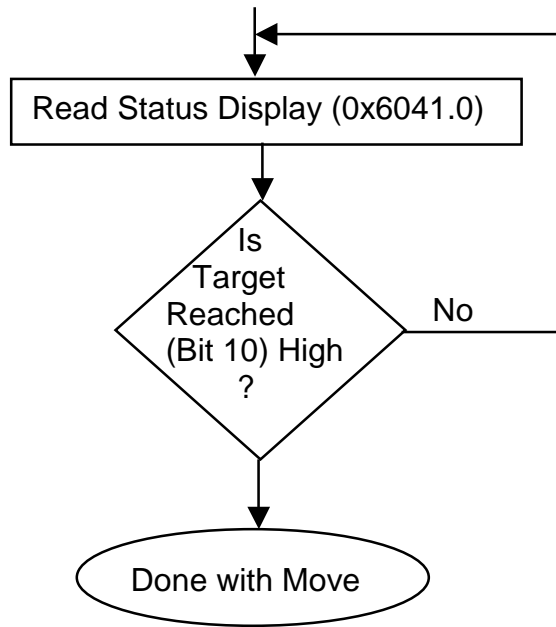

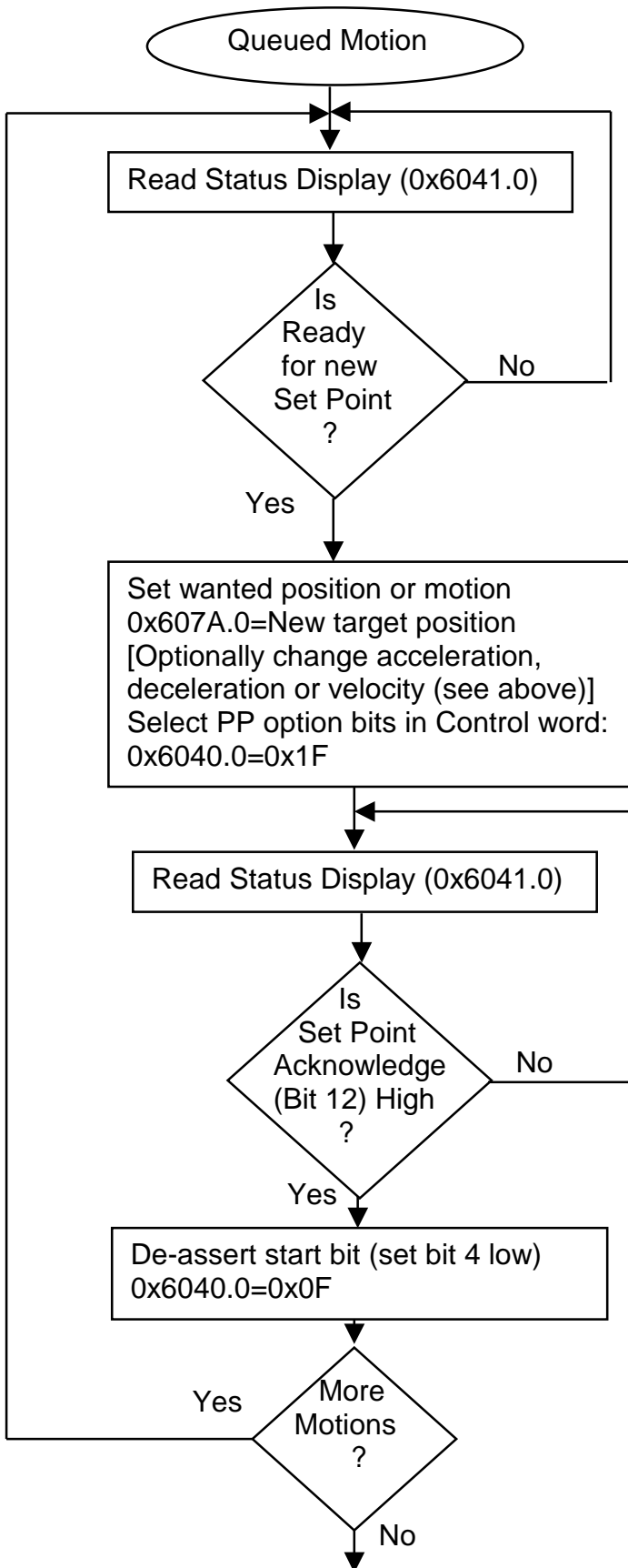

Perform multiple motions, letting each complete and wait for final motion to complete

In PP mode,
Bit 12 = Set point Acknowledge (0 if waiting for a new setpoint)

In example, Target is absolute, complete prior setpoint. No change immediate, no halt., start motion.
Code is 0x1F

PP specific bits in Control Word (0x6040.0)
 Bit 4 = New Set point
 Bit 5 = Change Set point immediately
 Bit 6 = absolute (0) / relative (1)
 Bit 8 = Halt current motion (1)
 Bit 9 = (0) Complete current set point before evaluating next (come to stop), (1) go to current set point at velocity, then transition to new accel/velocity to reach next setpoint.

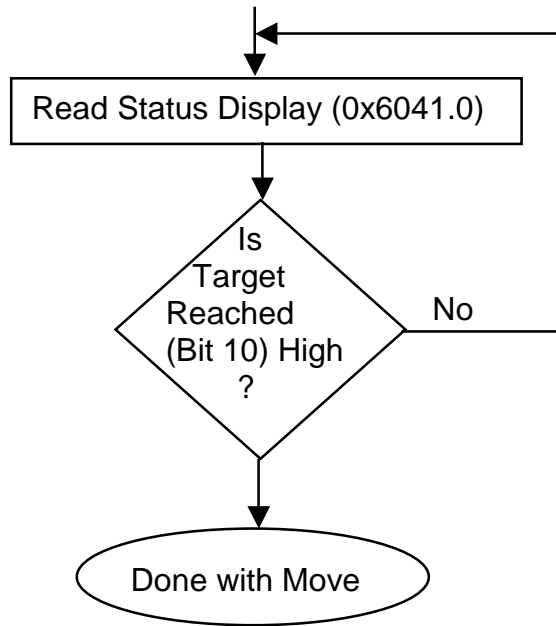

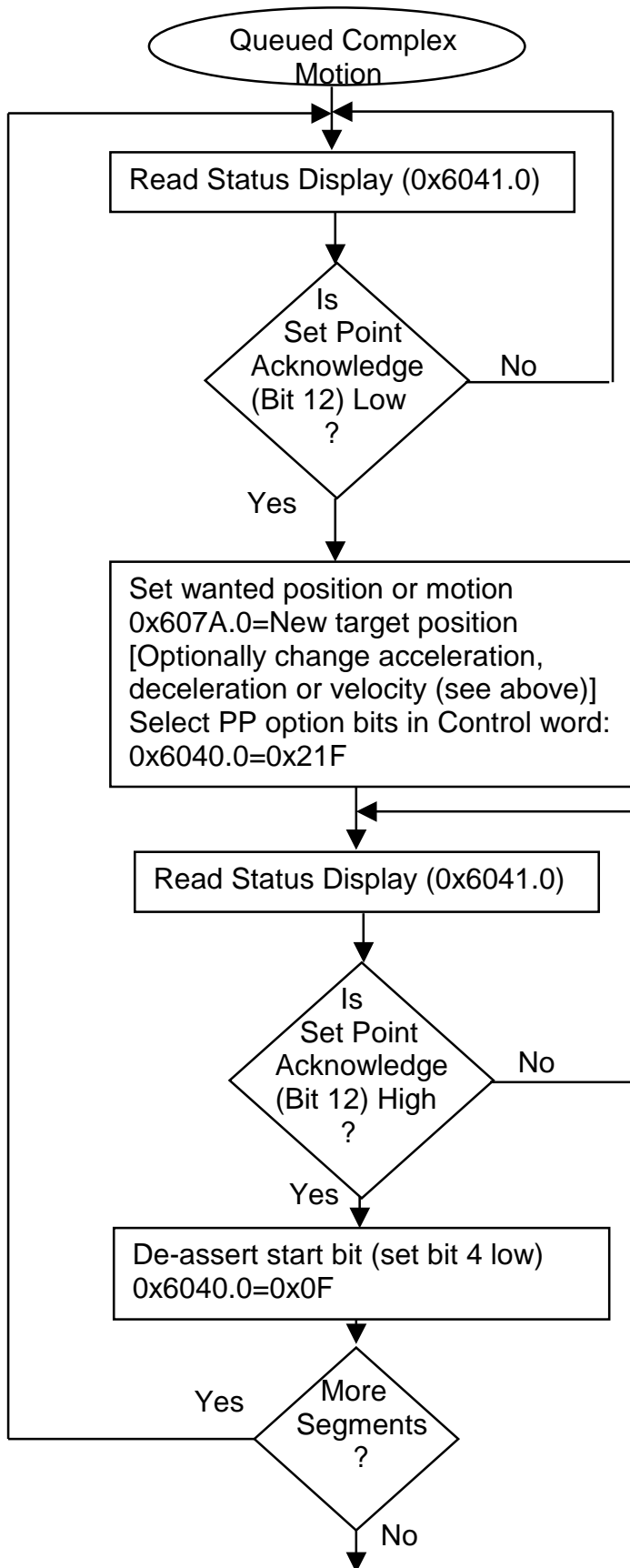

Perform multi-segment motions, blending motions and then waiting for final motion to complete

In PP mode,
Bit 12 = Set point Acknowledge (0 if waiting for a new setpoint)

In example, Target is absolute, transition at prior setpoint. No change immediate, no halt., start motion.
Code is 0x21F

PP specific bits in Control Word (0x6040.0)
 Bit 4 = New Set point
 Bit 5 = Change Set point immediately
 Bit 6 = absolute (0) / relative (1)
 Bit 8 = Halt current motion (1)
 Bit 9 = (0) Complete current set point before evaluating next (come to stop), (1) go to current set point at velocity, then transition to new accel/velocity to reach next setpoint.

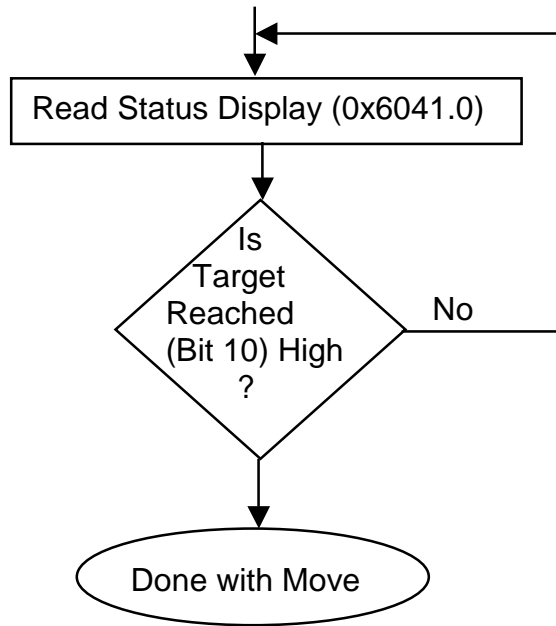

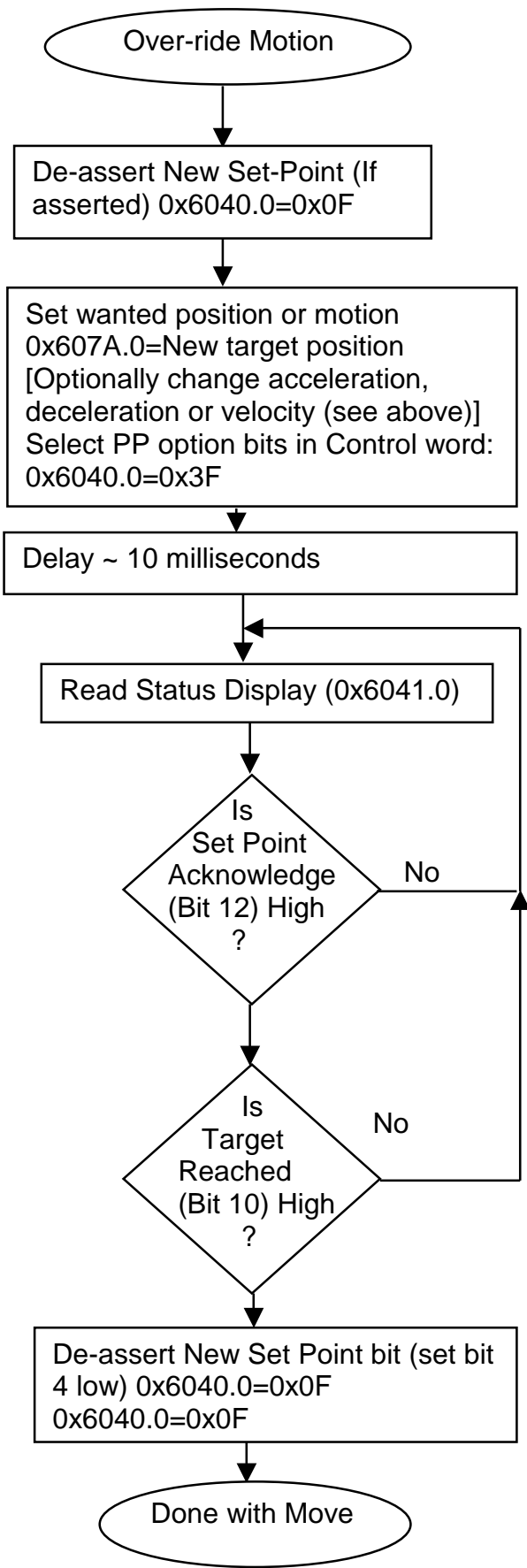

Override an existing motion

In example, Target is absolute, Change immediately, no halt, start motion.
Bit 5=1 for Change Immediately Code is 0x3F

The delay is a precaution to prevent reading the completion of the prior motion if the New Set Point bit was also left high (active) or a second motion was queued. An override with an active motion and a queued motion does not provide positive handshaking means to acknowledge the "Change Immediately" override command.

Wait for motion complete before de-asserting New Set Point Bit.